

SYN

L A S A I D E A
F A S H I O N B A T H R O O M



SYN

Design_Emanuel Gargano - Marco Fagioli



Da un progetto di Emanuel Gargano e Marco Fagioli, nasce SYN, un nuovo concetto di arredo bagno che coniuga un'estesa modularità e un design essenziale.

Gli elementi dalle proporzioni rigorose si compongono per costruire una spazialità alternativa, da declinare in legno, nobilitato e laccato.

Caratterizza la collezione il portavavabo in Tecnoril bianco o in Teknos in tutte le finiture disponibili.

Designed by Emanuele Gargano e Marco Fagioli, Syn is a new concept in the world of bathroom furnishings, and blends extensive modularity and essential design.

The well proportioned elements, lacquered and melamine-coated, are merged to create an alternative idea of space in the bathroom.

Fruit d'un projet d'Emanuele Gargano et Marco Fagioli, SYN est un nouveau concept d'aménagement de salles de bains qui associe une très grande modularité à un design épuré.

Les éléments, aux proportions rigoureuses, se combinent pour construire une spazialité alternative, à réaliser en bois, mélaminé et laqué. Le meuble de lavabo en Tecnoril ou Teknos, disponible dans toutes les finitions, caractérise la collection.

Nach einem Projekt von Emanuel Gargano und Marco Fagioli entsteht SYN, ein neues Einrichtungskonzept für Badezimmer, die umfangreiche Modularität und schlichtes Design unter einen Hut bringt.

Die Elemente in rigorosen Proportionen werden so kombiniert, dass räumliche Alternativen entstehen, wahlweise in Holz, Melamin und lackiert.

Charakterisiert wird die Kollektion durch den Waschtisch in Tecnoril weiß oder Teknos, in allen Ausführungen erhältlich.

elementi modulari per comporre infinite soluzioni

modular elements for infinite solutions
éléments modulaires pour composer une infinité de solutions
Modulelemente mit unendlichen Lösungsmöglichkeiten

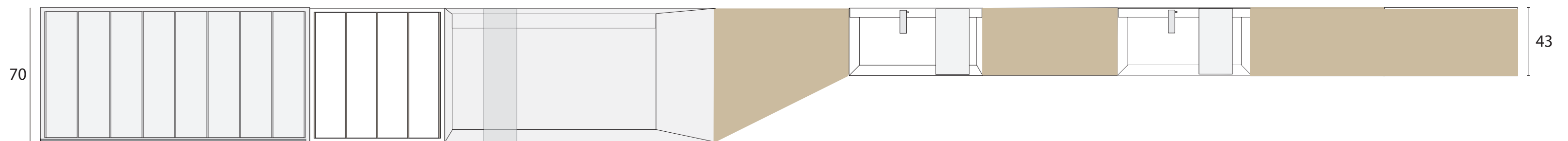

Solamente 43 cm di profondità.
Un grande lavabo e contenitori molto capienti.

Only 43 cm deep. A large sink and capacious cabinets.
Seulement 43 cm de profondeur. Un grand évier et et conteneurs spacieuses.
Nur 43 cm tief. Ein großes Waschbecken in geräumigen Schrank

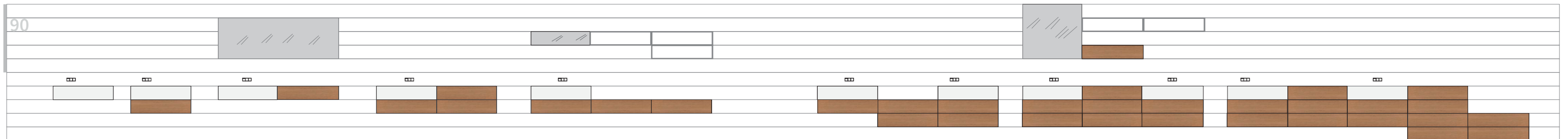
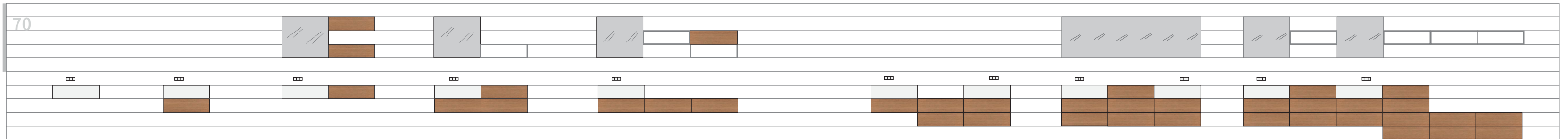
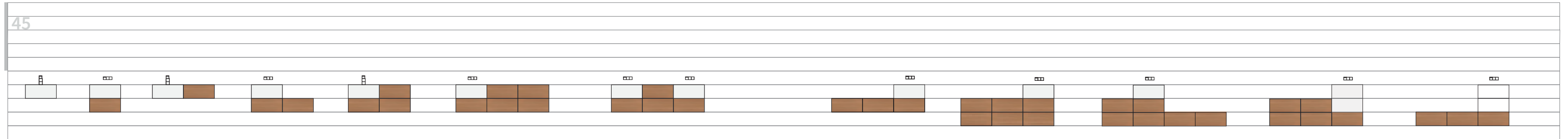



modularità
estesa
e flessibile
per spazi
innovativi

highly flexible and modular
for innovative spaces
modularité, flexible et rigoureuse
pour espaces innovants
flexible und rigorose Modularität,
für innovative Räume



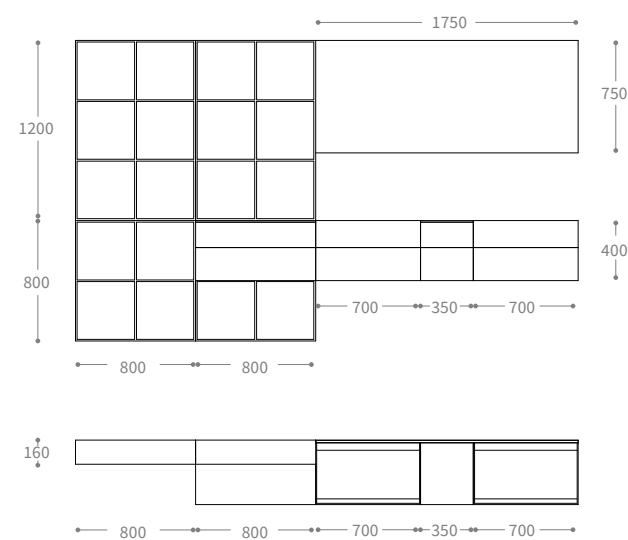

SYN 07 L. 335 P. 43 H. 200

finiture Olmo Naturale 7965_lavabi Tecnoril Bianco Opaco_apertura Push-Pull_specchiera filo lucido con luce LED sul lato basso e sul lato alto -art. SYN142 / finishing Olmo Naturale 7965_washbasins Tecnoril Matt White_push-pull opening_polished rim mirror with top and bottom LED lights -art. SYN142 / finition Olmo Naturale 7965_vasques Tecnoril Blanc Mat_ouverture avec Push-Pull_miroir avec chant poli et lumière LED supérieure et inférieure -art. SYN142 / Ausführung Ulme Natur 7965_ Waschbecken Tecnoril weiss matt_Push-Pull Öffnung_Spiegel mit polierter Kante mit Ober-und Unterlicht LED -art. SYN142





la purezza di
linee rigorose
e funzionali
per l'ambiente bagno

the purity of simple and functional lines for the bathroom

la pureté des lignes simples et fonctionnelles pour la salle de bain.

die Schlichtheit der rigorosen und funktionalen Linien für das Badezimmer



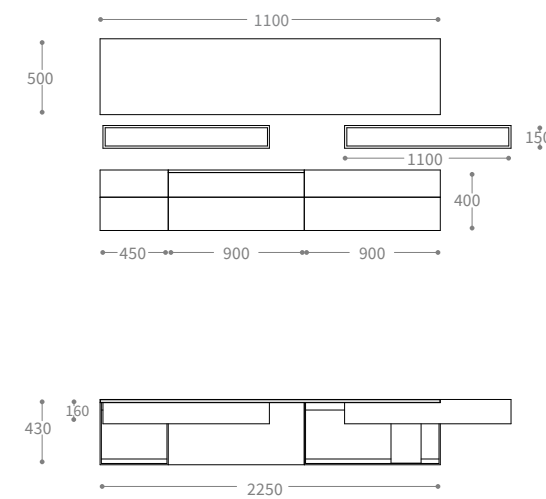

SYN 08 L. 225 P. 43 H. 195

finiture Laccato Burro Opaco M47_lavabi Teknos Burro_apertura Push-Pull_specchiera filo lucido con luce LED sul lato basso e sul lato alto -art. SYN142 / finishing Matt Burro M47 lacquered_washbasins Teknos Burro_push-pull opening_polished rim mirror with top and bottom LED lights - art. SYN142 / finition Laqué Burro M47 Mat_Vasques Teknos Burro_ouverture avec Push-Pull_miroir avec chant poli et lumière LED supérieure et inférieure - art. SYN142 / Ausführungen Lackiert Burro M47 Matt_Waschbecken Teknos Burro_Push-Pull Öffnung_Spiegel mit polierter Kante mit Ober und Unterlicht LED-Licht - art. SYN142



original ideas for the new organisation of space
des idées originales pour une nouvelle organisation des espaces
originelle Ideen für eine neue Organisation der Räumlichkeiten

soluzioni originali
per una nuova
organizzazione
degli spazi





SYN 09 L. 200 P. 43 H. 195

finiture quercia naturale 34141 / resina cemento beige_lavabi resina cemento beige_apertura basi push-pull / pensili apertura a gola_specchiera con cornice, mensola e luce led con sensore per accensione - art. syn117 / finishing quercia naturale 34141 / beige concrete_beige concrete washbasins_opening push-pull / wall-hung units opening with groove_mirror with frame, shelf and led light with "touch control" light sensor - art. syn117 / finition quercia naturale 34141 / résine béton beige_vasques concreteo beige_ouverture avec push-pull éléments hauts suspendus ouverture avec gorge_miroir avec encadrement, avec capteur pour allumage lumière touch - art. syn 117 / Ausführungen quercia naturale 34141 / kunstharze cemento beige_Waschbecken kunstharze cemento beige_Öffnung push-pull öffnung / hängeschränke öffnung mit mulde_spiegel mit rahmen und led licht mit lichtsensor - art. syn142





Ogni elemento compositivo SYN può essere personalizzato con la finitura in resina cementizia
Each SYN element can be customised with a concrete finishing
Chaque élément de la composition SYN peut être personnalisé avec une finition résine béton.
Jedes Kombinations-Element SYN kann mit Finish aus Zementharz personalisiert werden



Composizioni semplici. Soluzioni infinite anche con pochi elementi

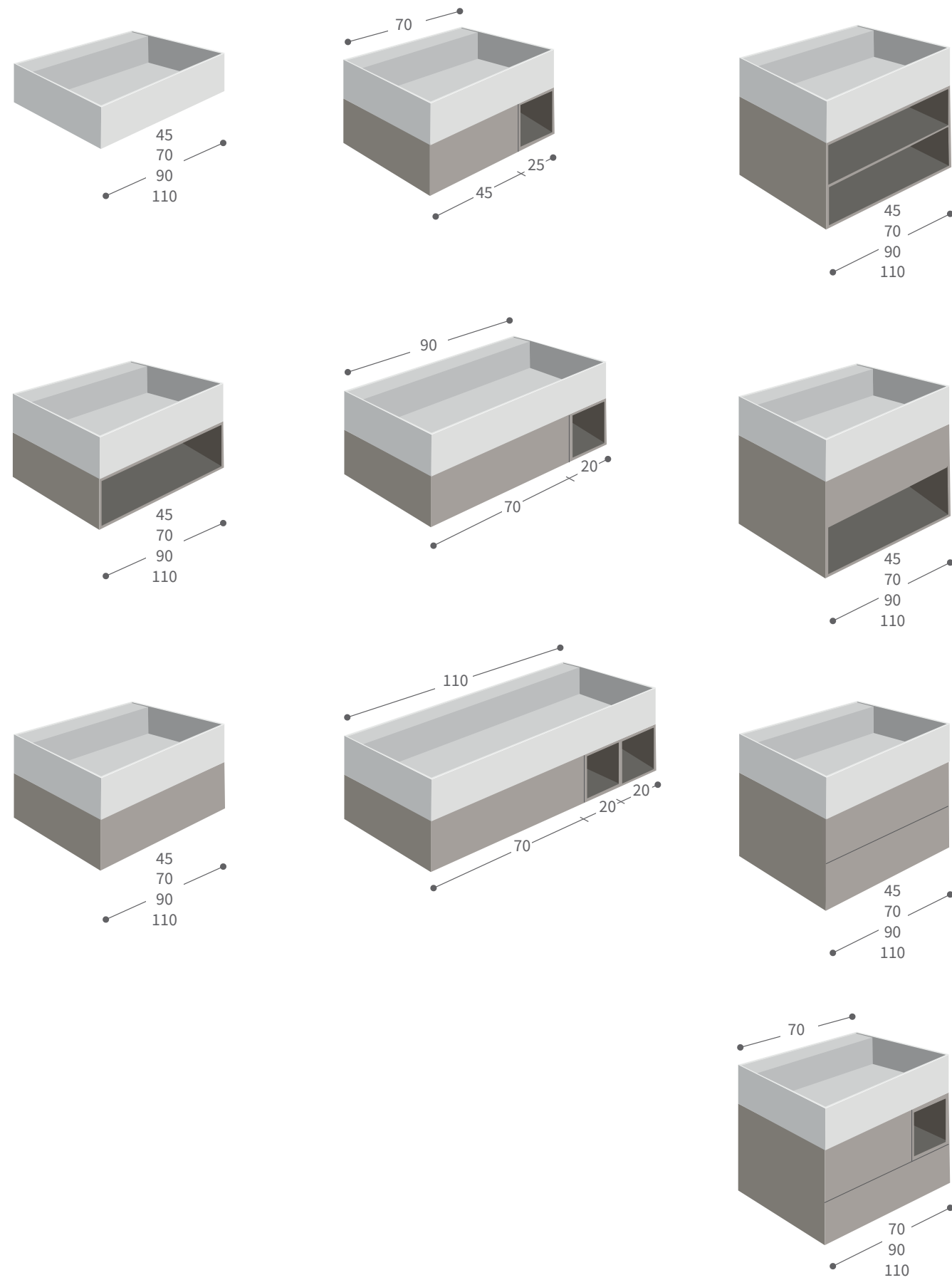

Simple compositions. Infinite solutions even with few elements. Compositions simples. Une infinité de solutions même avec peu d'éléments. Compositions simples. Une infinité de solutions même avec peu d'éléments.

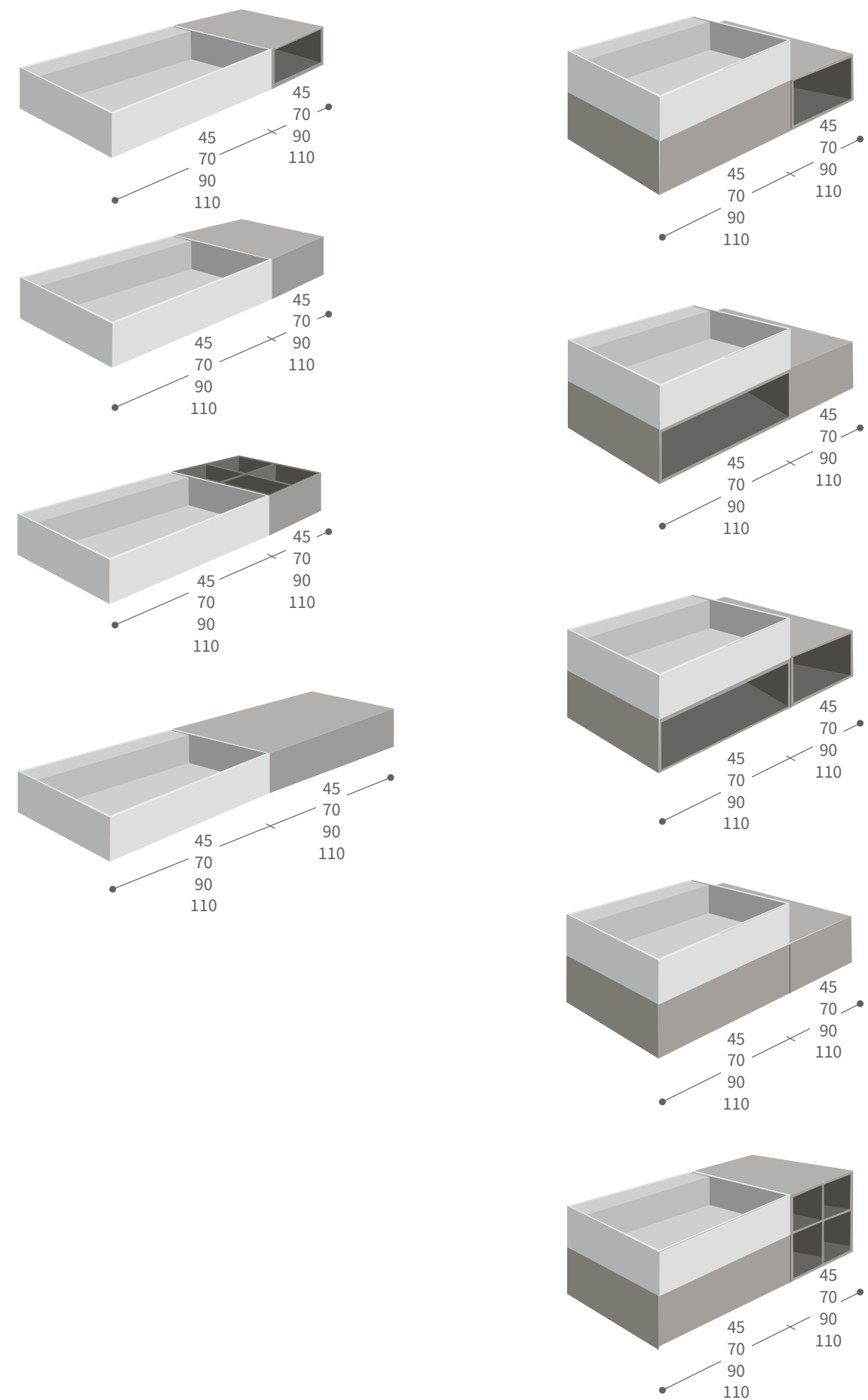



materiali
e colori
coordinati
in ogni
elemento

materials and colours coordinated for each element
matériaux et couleurs coordonnés pour chaque élément
koordinierte Materialien und Farben in jedem Element







Il Teknos può essere utilizzato per lavabi, piatti doccia e vassoio scorrevole coordinato in tinta con i mobili
 Teknos can be used for sinks, showers and sliding trays coordinated to match the furniture
 Teknos peut être utilisé pour les éviers, les receveurs de douche et les plateaux coulissants coordonnés avec la teinte des meubles.
 Teknos kann für Waschbecken, Duschwannen und Schiebetrays verwendet werden, die passend zu den Möbeln koordiniert sind

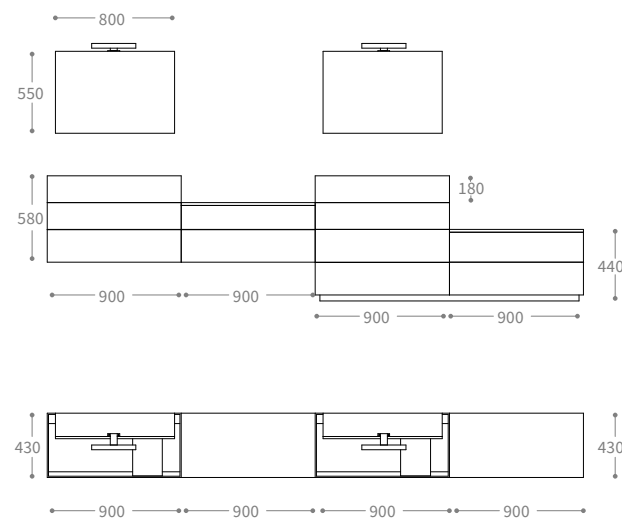

SYN 01 L. 360 P. 43 H. 195

finiture laccato creta opaco M50_lavabi teknos creta_apertura push-pull_specchiera specchio contenitore vasistas con ripiano interno in cristallo - art. M80 + essential4 /
 finishing matt creta m50 lacquered_washbasins teknos creta_opening: push-pull_mirror cabinet with lift-up door and glass interior shelf -art. M80 + essential4 /
 finition laqué creta m50 mat_vasque teknos creta_ouverture avec push-pull_miroir armoire de toilette avec porte miroir relevable et tablette intérieure en verre - art. M80 +
 essential4 / Ausführungen Lackiert Creta M50 Matt_Waschbecken Teknos Creta_Push-Pull Öffnung_Spiegel: mit Klapptür nach oben und innerem Glaseinlegeboden - art.
 M80 + ESSENTIAL4





linee rigorose e volumi compatti

design both rigorous and space-efficient
un concept, avec des lignes nettes et des volumes compacts
ein Design mit strengen Linien und kompaktem Volumen

SYN10





Specchio contenitore bifacciale completo di illuminazione
 Double-sided mirror cabinet with lighting
 Armoire de toilette à miroir double face et avec éclairage.
 Doppelseitiger Spiegelschrank komplett mit Beleuchtung

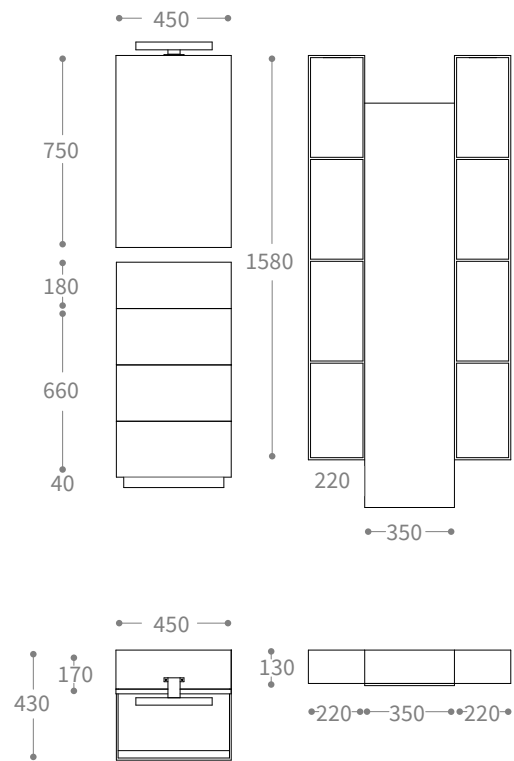

SYN 10 L. 450+790 P. 43 H. 195

finiture laccato pietra serena opaco M49_lavabo Teknos pietra serena_apertura anta con gola_specchio contenitore 1 anta a specchio bifacciale dx-sx con ripiani interni in cristallo - art.syn126 + essential4 / finishing matt pietra serena M49 lacquered_washbasins Teknos pietra serena_apertura door with groove_mirror cabinet with two-faced mirror door and glass interior shelves - art. syn126 + essential4 / finition laqué pietra serena M49 mat_vasques Teknos pietra serena_ouverture porte avec gorge_miroir armoire de toilette avec 1 porte miroir bifacial d-g et tablettes_intérieures en verre - art. syn126 + essential4 / Ausführungen lackiert pietra serena M49 matt_Waschbecken Teknos pietra serena_Türöffnung mit Griffmulde_Spiegel mit 1 Tür r-l und Innenfachböden aus Glas- art. syn126 + essential4



SYN06



SYN 40_lavabo_washbasin_vasques_waschbecken

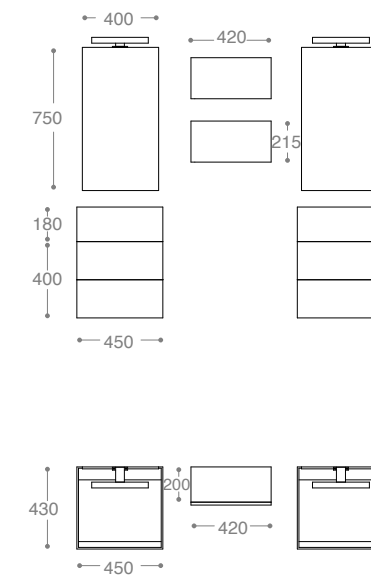

SYN 06 L. 450+420+450 P.43 H. 195

finiture laccato lavanda lucido G76_lavabi Tecnoril bianco lucido_apertura push-pull_specchiera filo lucido -art. ma20/40 + essential4 / finishing glossy lavanda G76 lacquered_washbasins Tecnoril glossy white_opening push-pull_polished rim mirror - art. ma20/40 + essential4 / finition laqué lavanda G76 brillant _vasques Tecnoril blanc brillant _ouverture avec push-pull_miroir avec chant poli -art. ma20/40 + essential4 / Ausführungen lackiert lavanda G76 hochglanz_Waschbecken Tecnoril weiss hochglanz_Öffnung push-pull öffnung_Spiegel mit polierter Kante - art. ma20/40 + essential4



effetti legno e colori laccati,
abbinamento nobile
e contemporaneo

wood effects and lacquered colours for a noble and contemporary combination
effets bois et couleurs laquées, combinaison noble et contemporaine
einzigartige Effekte von Holz und Farben, edle und moderne Kombinationen



Specchio contenitore modulare con specchio bifacciale
Modular mirror with double-sided mirror
Armoire de toilette modulaire avec miroir double face
Modularer Spiegelschrank mit einem doppelseitigem Spiegel



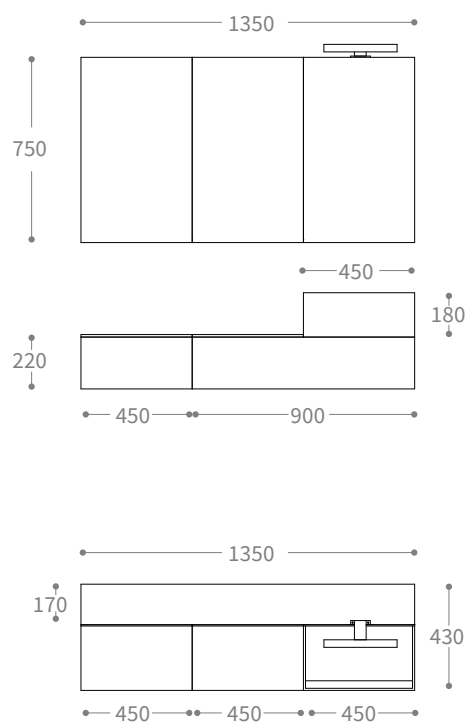

SYN 11 L. 135 P. 43 H. 195

finiture rovere rustico 14140_lavabo Tecnoril bianco opaco _apertura push-pull_specchiera specchio contenitore 3 ante a specchio bifacciali con ripiani interni in cristallo - art. syn130 + essential4 / finishing rovere rustico 14140_washbasins Tecnoril matt white_push-pull opening_mirror double-fronted wall unit with 3 mirrored doors and glass interior shelves - art. syn130 + essential4 / finition rovere rustico 14140_vasques Tecnoril blanc mat_ouverture avec push-pull miroir élément haut avec 3 portes miroir double face et tablettes intérieures en verre. - art. syn130 + essential4 / Ausführungen Eiche rustikal 14140_Waschbecken Tecnoril weiss matt_Öffnung push-pull öffnung_Spiegel Hängeschrank mit beidseitig ausgeführten spiegeltüren, Innenfachböden aus Glas - art. syn130 + essential4





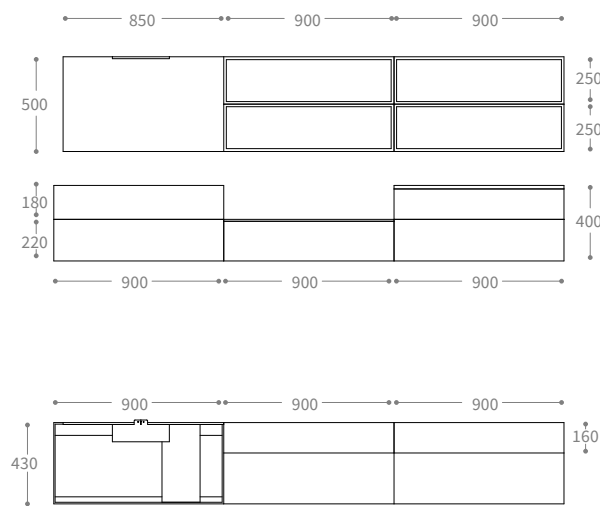

SYN 03 L. 270 P. 43 H. 195

finiture noce canaletto naturale NC30_lavabi Tecnoril bianco opaco_apertura push-pull_specchiera specchio filo lucido - art. MC23/85 + essential1 / finishing noce canaletto naturale NC30_washbasins Tecnoril matt white_push-pull opening_mirror polished rim mirror with - art. MC23/85 + essential1 / finition noce canaletto naturale NC30_vasques Tecnoril blanc mat_ouverture avec push-pull_miroir avec chant poli - art. MC23/85 + essential1 / Ausführungen noce Walnuss naturale NC30_Waschbecken Tecnoril weiss matt_Öffnung push-pull_Spiegel mit polierter Kante - art. MC23/85 + essential1



capacious and elegant in its colour scheme and design
spacieuse et élégante dans des couleurs et aux lignes
geräumig und elegant in Farben und Linien

capiente
ed elegante
nei colori
e nella
linea

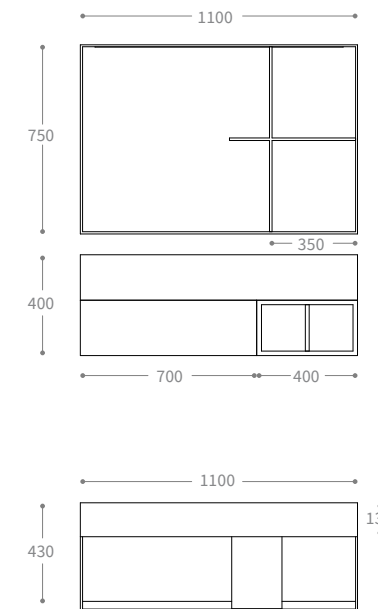
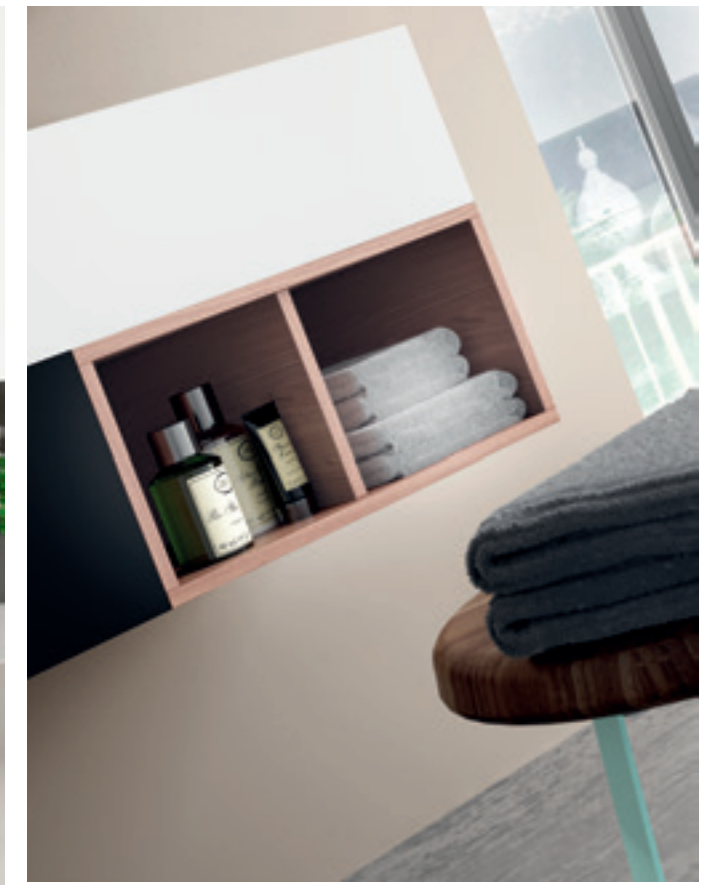

SYN 12 L. 110 P. 43 H. 195

finiture Olmo Siena 7967 / Laccato Grigio Ardesia Opaco M89_lavabi Tecnoril Bianco Opaco_apertura Push-Pull_specchiera con cornice, mensola e luce LED con sensore per accensione e griglia porta oggetti - art. SYN117 + art. SYN200 / finishing Olmo Siena 7967 / Matt Grigio Ardesia M89_lacquered_washbasins Tecnoril Bianco Opaco_push-pull opening_mirror with frame, shelf and LED light with "Touch control" light sensor and shelves-grid - art. SYN117 + art.SYN200 / finition Olmo Siena 7967 / Laqué Grigio Ardesia M89_Mat_vasques Tecnoril Bianco Opaco_ouverture: avec Push-Pull_miroir avec encadrement Olmo Siena avec capteur pour allumage lumière Touch et grille porte-objets - art. SYN117 + art SYN200 / Ausführungen Ulme Siena 7967 / Lackiert Grigio Ardesia M89_Matt_Waschbecken Tecnoril Bianco Opaco_Push-Pull Öffnung_Spiegel mit Rahmen und LED Licht mit Lichtsensor und Gitterablage - art. SYN142 + art. SYN200



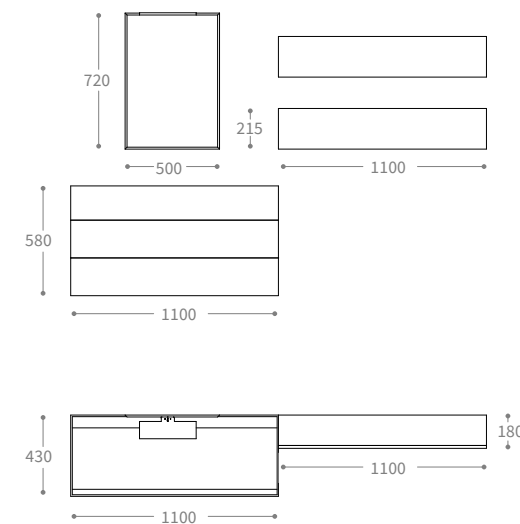

SYN 02 L. 110 P. 43 H. 195

finiture Laccato Bianco Lucido G86_lavabi Tecnoril Bianco Lucido_apertura Push-Pull_specchiera filo lucido - art. MC27 + Essential1_vasca da bagno Tecnoril Bianco Lucido cm 170x70x50h -art. Shape01 / finishing Glossy White G86 lacquered _washbasins Tecnoril Glossy White_push-pull opening_polished rim mirror - art. MC27 + Essential1_freestanding Bathtub Tecnoril glossy White cm 170x70x50h -art. Shape01 / finition Olmo Siena 7967 / Laqué Grigio Ardesia M89 Mat_vasques Tecnoril Blanc brillant_ouverture avec Push-Pull_miroir avec chant poli - art. MC27 + Essential1_baignoire Tecnoril Blanc brillant cm 170x70x50h - art. Shape01_Ausführungen Olmo Siena 7967 / Lackiert Grigio Ardesia M89 Matt_Waschbecken Tecnoril weiss Hochglanz _Push-Pull Öffnung _Spiegel: mit polierter Kante - art. MC27 + Essential1_Badewanne Tecnoril weiss Hochglanz cm 170x70x50h -art. Shape01

SYN04

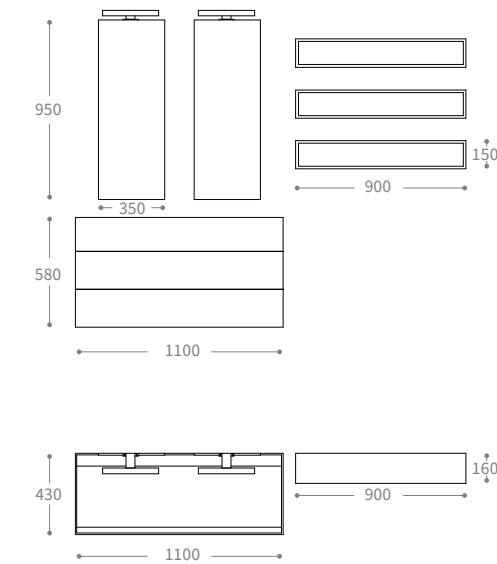

SYN 04 L. 110 P. 43 H. 195

finiture Laccato Cappuccino Lucido G51_lavabi Tecnoril Bianco Opaco_apertura Push-Pull_specchiera filo lucido - art. BC-5A + ESSENTIAL4 / finishing Glossy Cappuccino G51 lacquered_washbasins Tecnoril Matt White_push-pull opening_mirror polished rim mirror - art. BC-5A + ESSENTIAL4 / finition Laqué Cappuccino G51 Brillant / Vasques Tecnoril Blanc Mat_ouverture avec Push-Pull_miroir avec chant poli - art. BC-5A + ESSENTIAL4 / Ausführungen Lackiert Cappuccino G51 Hochglanz_Waschbecken Tecnoril Weiss Mat_Push-Pull Öffnung_Spiegel mit polierter Kante - art. BC-5A + ESSENTIAL4



un lavabo grande
e capiente in soli
43 cm di profondità

a large and capacious sink only 43 cm deep.
un grand et spacieuse évier seulement dans 43 cm de profondeur.
ein Waschbecken groß und geräumig in nur 43 cm tief

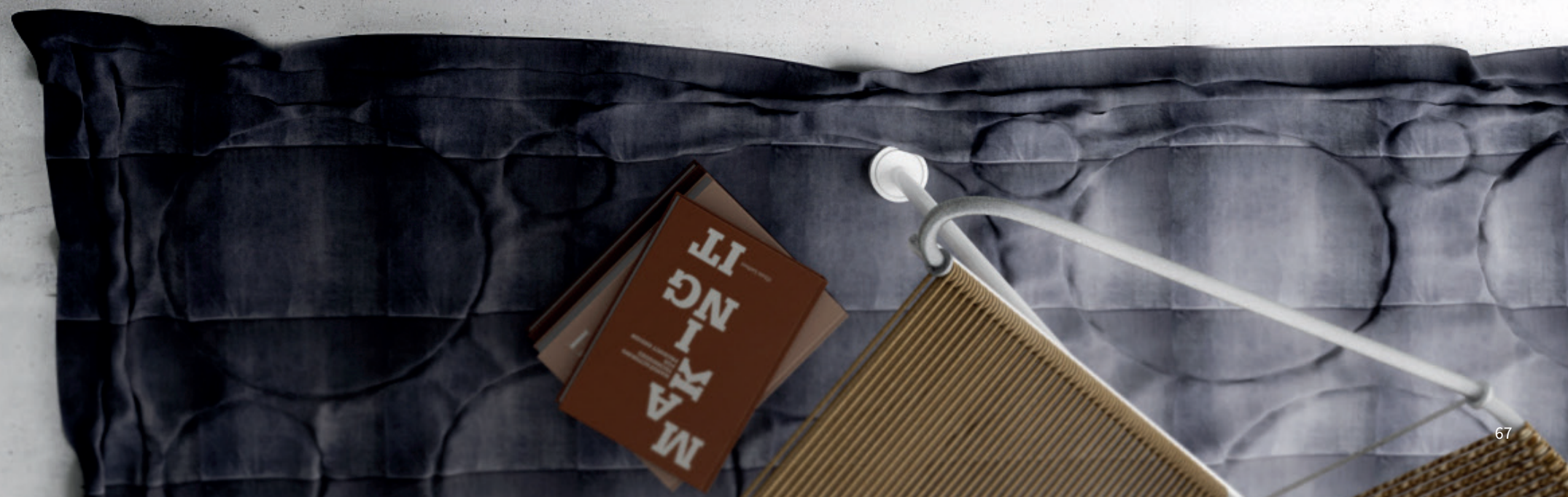

SYN05

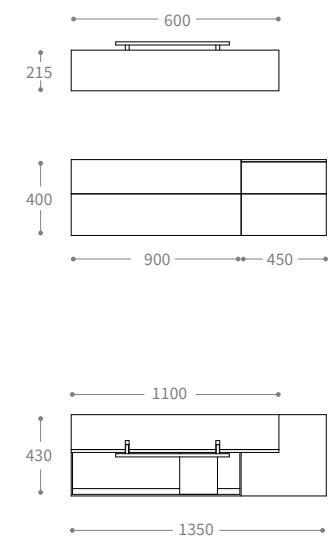

SYN 05 L. 135 P.43 H. 190

finiture laccato cuoio opaco M45_lavabi Teknos cuoio_apertura push-pull_specchiera specchio contenitore vasistas - art. SYN59 + essential6 / finishing matt cuoio M45 lacquered_washbasins Teknos cuoio_push-pull opening_mirror cabinet with lift-up door - art. SYN59 + essential6 / finition laqué cuoio M45 mat_vasques Teknos cuoio_ouverture avec push-pull_miroir armoire de toilette avec porte miroir relevable - art. SYN59 + essential6 / Ausführungen lackiert cuoio M45 matt_Waschbecken Teknos cuoio_öffnung push-pull Öffnung_Spiegel mit Klapptür nach oben - art. SYN59 + essential6

impeccable design using only the finest materials
géométriques impeccables, réalisée avec d'excellents matériaux
lupenreine Geometrien in außergewöhnlichen Materialien interpretiert

geometrie
ineccepibili
interpretate
da materiali
eccellenti



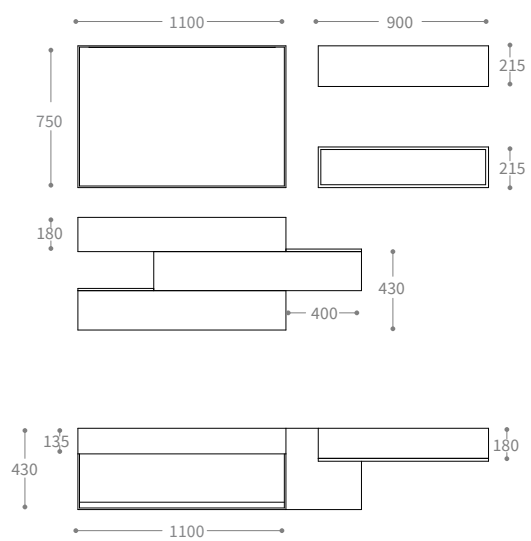

SYN 13 L. 150+90 P. 43 H. 195

finiture Olmo Roccia 4056 / Laccato Bianco Opaco M86_lavabi Tecnoril Bianco Opaco_apertura con maniglia_specchiera con cornice, mensola e luce LED con sensore per accensione -art. SYN117 / finishing Olmo Roccia 4056 / Matt White M86 lacquered_washbasins Tecnoril Matt White_opening with handle_mirror: With frame, shelf and LED light with "Touch control" light sensor -art. SYN117 / finition Olmo Roccia 4056 / Laqué Blanc M86 Mat_vasques Tecnoril Blanc Mat_ouverture avec poignée_miroir avec encadrement Olmo Roccia avec capteur pour allumage lumière Touch -art. SYN117 / Ausführungen Olmo Roccia 4056 / lackiert Weiss M86 Matt_Waschbecken: Tecnoril Weiss Matt_Öffnung mit Griff_Spiegel mit Rahmen und LED Licht mit Lichtsensor - art. SYN117



Specchio con cornice, mensola e luce LED integrata
Framed mirror with shelf and built-in LED light
Miroir encadré, étagère et lumière LED intégrée
Gerahmter Spiegel mit Ablage und integriertem LED-Licht



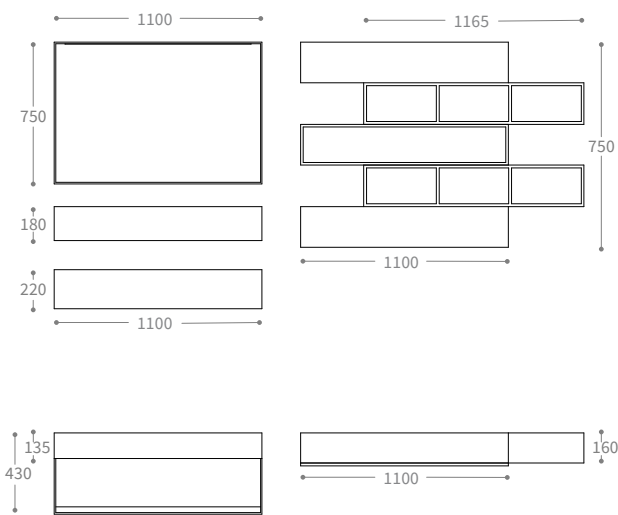

SYN 14 L. 110+150 P. 43 H. 195

finiture Olmo Lava 4055 / Laccato Burro Opaco M47_lavabi Teknos Burro_apertura con maniglia_specchiera con cornice, mensola e luce LED con sensore per accensione - art. SYN117 / finishing Olmo Lava 4055 / Matt Burro M47 lacquered_washbasins Teknos Burro_opening with handle_mirror with frame, shelf and LED light with "Touch control" light sensor - art. SYN117 / finition Olmo Lava 4055 / Laqué Burro M47 mat_vasques Teknos Burro_ouverture avec poignée_miroir avec encadrement Olmo Roccia avec capteur pour allumage lumière Touch - art. SYN117 / Ausführungen: Olmo Lava 4055 / Lackiert Burro M47 Mat_Waschbecken Teknos Burro_Öffnung mit Griff_Spiegel mit rahmen und LED Licht mit Lichtsensor - art. SYN117



a clever and sophisticated use of space
une utilisation intelligente et sophistiquée de l'espace
eine gekonnte und raffinierte Raumnutzung

un sapiente
e raffinato
uso dello
spazio

SYN15



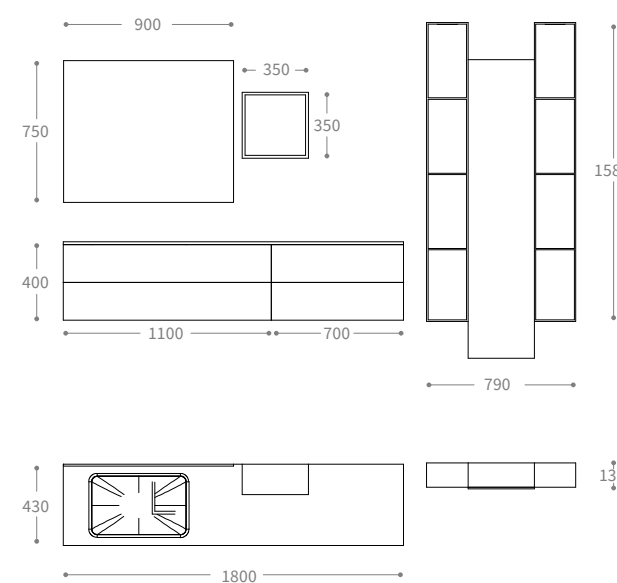

SYN 15 L. 180+79 P. 43 H. 195

finiture Laccato Azzurro Artico Opaco M80_lavabi Cristallo Sabbiato Azzurro Artico Opaco M80_apertura Maniglia laccata in tinta con il mobile_specchiera Filo lucido con luce LED sul lato basso e sul lato alto -art. SYN134 / finishing Matt Azzurro Artico M80 lacquered_washbasins: Azzurro Artico M80 sandblasted glass_opening with lacquered handle _mirror Polished rim mirror with top and bottom LED lights -art. SYN134 / finition Laqué Azzurro Artico M80 Mat_vasques Verre sablé Azzurro Artico M80_ouverture avec poignée laqué _miroir avec chant poli et lumière LED supérieure et inférieure -art. SYN134 / Ausführungen Lackiert Azzurro Artico M80 Matt_Waschbecken Glas sandgestrahlt Farbe Azzurro Artico M80_Öffnung mit Griff lackiert_Spiegel mit polierter Kante mit Ober und Unterlicht LED-Licht - art. SYN134



piatti doccia slim

Slim shower trays
 Receveurs de douche Slim
 Duschwannen Slim

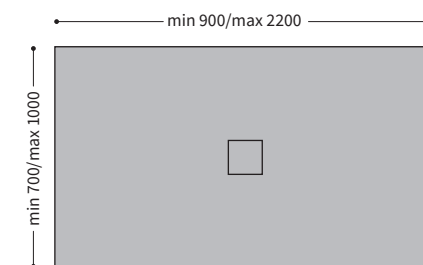

piatto doccia su misura, disponibile nella versione in appoggio o filo pavimento_made to measure shower tray, available for flush fitting or freestanding versions _receveur de douche sur mesure, disponible en installé à poser ou installé au niveau du sol)_Duschwanne zugeschnitten, aufliegend oder bodenbündig erhältlich

piatti doccia slim

Slim shower trays
 Receveurs de douche Slim
 Duschwannen Slim

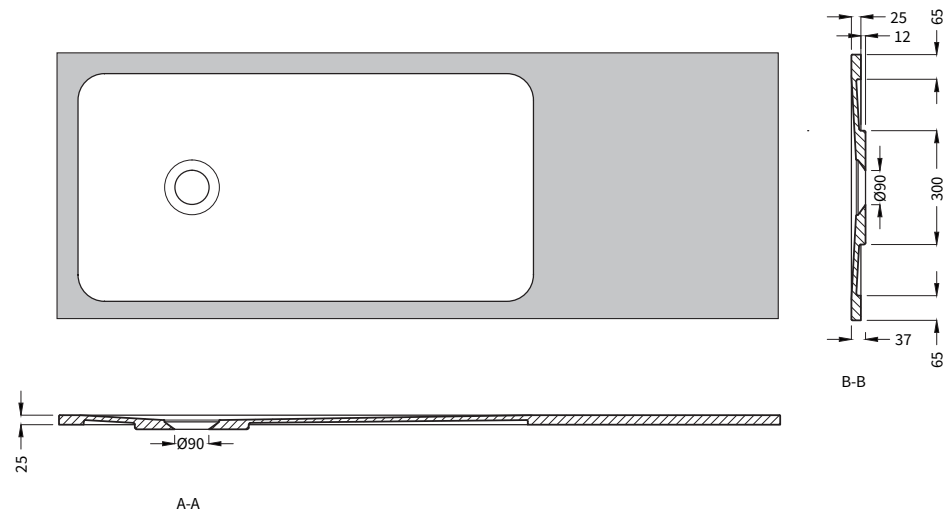

Piatto doccia da appoggio
 Shower tray installed on the floor level
 Receveur de douche installé à poser
 Aufliegende Duschwanne

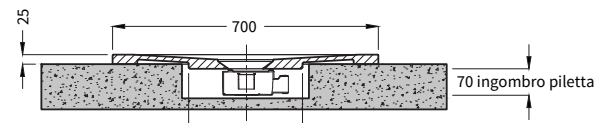

Piatto doccia filo-pavimento
 Shower tray installed at floor level
 Receveur de douche installé au niveau du sol
 Bodenbündige Duschwanne

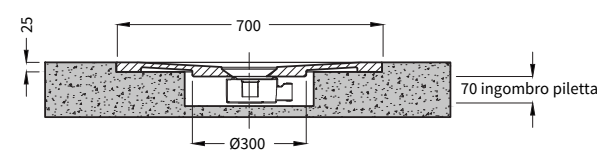

Finiture_Finishes_Finitions_Oberflächen

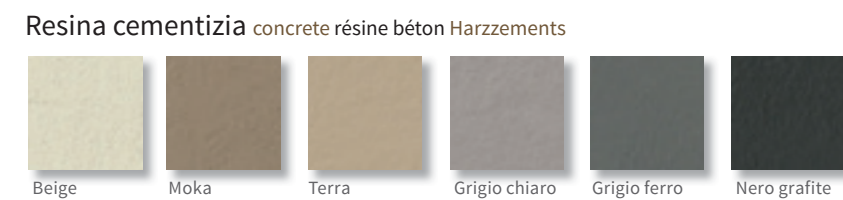
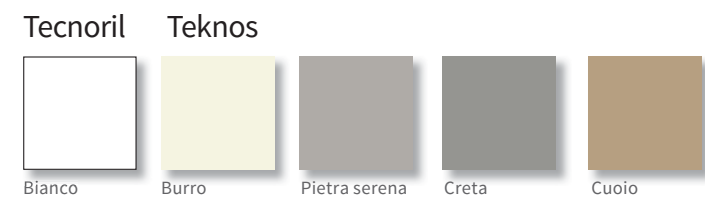

Shape free-standing



Shape closed



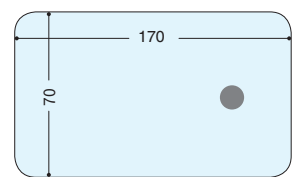

ART. SHAPE01
vasca free standing cm 170x70x50 h
disponibile in Tecnoril, in Teknos e resina cementizia.

free standing bathtub, available 170x70x50 h cm h 50 cm are made of Tecnoril, Teknos and concrete.

baignoire de 170x70x50 h cm disponible en Tecnoril, en Teknos et résine béton.

Badewanne freistehend von cm 170x70x50 h erhältlich in Tecnoril, in Teknos und Harzzements.

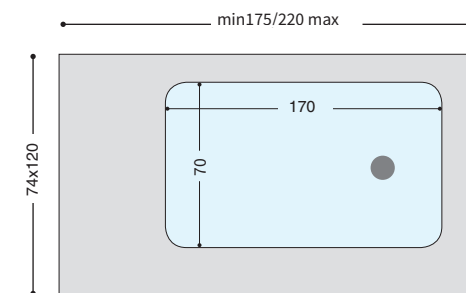

art. SHAPE02
vasca pannellabile free standing o da appoggio a parete realizzabile a misura da cm 175/220x74/120x50 h disponibile in Tecnoril, in Teknos e resina cementizia.

free standing and wall-mounted bathtub with enclosure panels, available 175/220x74/120 cm h 50 cm made of Tecnoril, Teknos and concrete.

baignoire avec panneaux posés autour d'elle réalisable sur mesure de 175/220x74/120x50 h cm disponible en Tecnoril, en Teknos et résine béton.

Badewanne freistehend oder wandmontiert, in den Versionen von cm 175/220x74/120x50 h realisierbar erhältlich in Tecnoril, in Teknos und Harzzements.

Finiture_Finishes_Finitions_Oberflächen

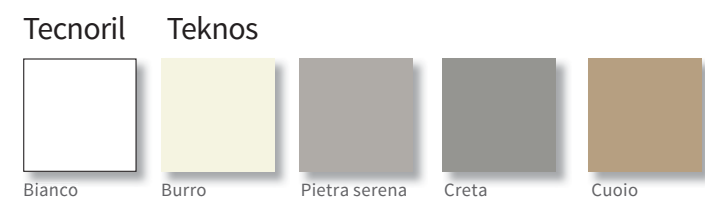

colori coordinati

coordinated colors couleurs coordonnées Farben koordiniert

lavabi washbasins lavabos becken

Tecnoril

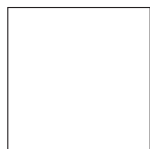

Bianco
opaco/lucido
matt/glossy
brillante et mat
glänzend und matt

Teknos

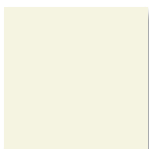

Burro



Pietra serena



Creta



Cuoio

Per sottolineare l'effetto monolitico della composizione è possibile coordinare la tinta del lavabo e del contenitore realizzati in materiali diversi.

The colour of a basin and container made of different materials can be coordinated to emphasize the monolithic effect of the whole.

Pour accentuer l'effet monolithique de la composition il est possible de coordonner la couleur de l'évier et de l'armoire réalisés dans des matériaux différents.

Um die monolithische Wirkung der Komposition zu betonen, kann die Farbe des Waschbeckens und des Behälters aus unterschiedlichen Materialien koordiniert werden.

mobili furniture meubles Möbelstücke

laccati

abbinabili ai colori Teknos
Lacques matched to Teknos colors
Laqués unis associés aux couleurs Teknos
Lackfarben auf Teknos abgestimmt

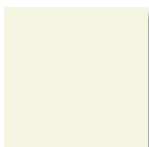

Burro



Pietra serena



Creta



Cuoio

50 colori laccati Lasaidea nella versione lucida e opaca.

Su richiesta disponibili colori Ral.

50 colours Lasaidea range of glossy and matt lacquers.

RAL colours available on request.

50 couleurs laqués Lasaidea dans la version brillante et mat.

Couleurs RAL disponibles sur demande.

50 Farben Lasaidea, lackiert, in den Versionen glänzend und matt RAL-Farben auf Anfrage erhältlich..

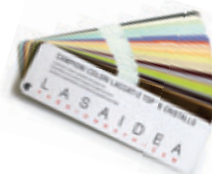

resina cementizia concrete résine béton Harzzements

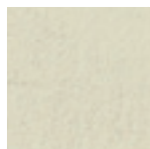

Beige

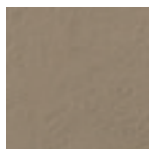

Moka

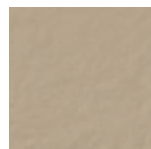

Terra

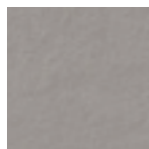

Grigio chiaro

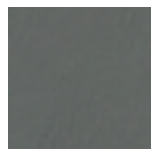

Grigio ferro

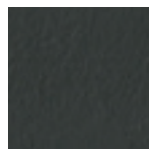

Nero grafite

La resina cementizia è utilizzabile per lavabi e contenitori con anta e a giorno
The concrete finishing is used for sinks and cabinets with or without doors

La résine béton est utilisable pour les éviers et les armoires avec ou sans porte.

Der Zementharz kann für Waschbecken, Schränke mit Türen und offene Regale verwendet werden

nobilitati materici melamine double barriered mélaminé finition bois renforcée double Melamineharzbeschichtungen

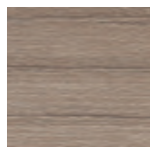

olmo naturale
7965

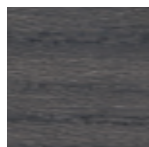

olmo lava
4055

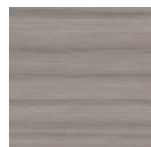

olmo roccia
4056

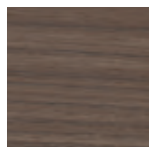

olmo siena
7967



larice bianco
7744



quercia naturale
34141



rovere rustico
14140



Promenade
Bianco PB7

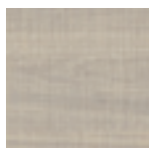

Promenade Corda
PCR6

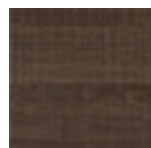

Promenade
Tabacco PC4

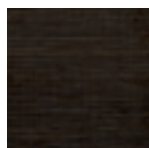

Promenade
Cioccolato PC3

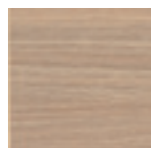

Promenade Rovere
sbiancato PRS5

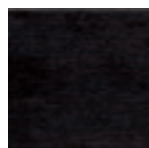

Promenade Wenge
PW2

legni / wood species / Finitions bois / Holzarten



rovere sbiancato
RS02

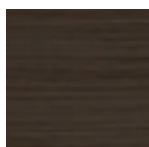

wenge WE01

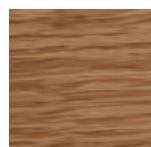

rovere ciliegio
RC04



rovere poro aperto
laccato bianco
RLB20



rovere grigio
cenere RC07



rovere corda
RCD32

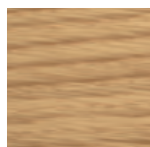

rovere naturale
RN06

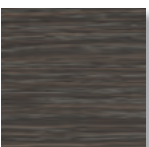

rovere ardesia
RA24

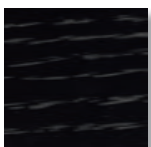

rovere poro aperto
laccato nero
RLN22

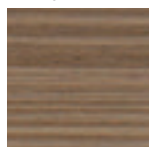

noce canaletto
naturale NC30



noce canaletto
sbiancato NCS31



rovere petrolio
RP08

L A S A I D E A

F A S H I O N B A T H R O O M

LASAIDEA S.p.A.

Strada di Gabbricce, 13 - 53035 Monteriggioni (SI)

tel. 0577.304296-304290 / fax 0577.304683

fax (vendite) +39.0577.304776

tel. export +39 0577.307526

www.lasaidea.com - info@lasaidea.com

M A D E I N I T A L Y

