

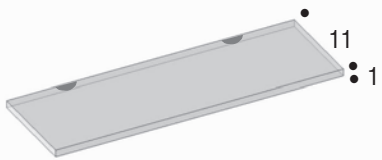

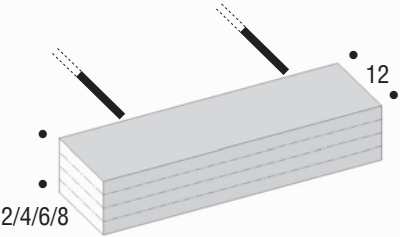

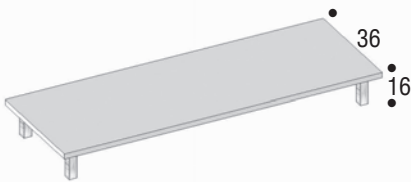

Elemento	Articolo	Larghezza	Altezza			
 <p>mensola cristallo attacchi parete cromo</p>	BC-8	al cm	1	Cristallo trasparente o satinato Prezzo al cm lineare Cristallo colorato (colori di serie) Prezzo al cm lineare Addebito minimo		
 <p>mensola in legno, con attacchi a scomparsa</p>	MC-F7A	al cm	2 cm	Laccato Opaco	Laccato Lucido	Legno
	MC-F7B	al cm	4 cm	* disp.	* disp.	* disp.
	MC-F7C	al cm	6 cm	* disp.	* disp.	* disp.
	MC-F7D	al cm	8 cm	* disp. * prezzo al cm addebito minimo	* disp. * prezzo al cm addebito minimo	*v * prezzo al cm addebito minimo
  <p>panchetto in MDF laccato o in legno con piedini in metallo cromato o ruote. specificare sull'ordine se versione con ruote o con piedini</p>	MA10-68	68	16	disp.	disp.	disp.
	MA10-85	85	16	disp.	disp.	disp.
	MA10-92	92	16	disp.	disp.	disp.
	MA10-102	102	16	disp.	disp.	disp.
	MA10-109	109	16	disp.	disp.	disp.
	MA10-116	116	16	disp.	disp.	disp.
	MA10-119	119	16	disp.	disp.	disp.
	MA10-126	126	16	disp.	disp.	disp.
	MA10-136	136	16	disp.	disp.	disp.
	MA10-140	140	16	disp.	disp.	disp.
	MA10-143	143	16	disp.	disp.	disp.
	MA10-150	150	16	disp.	disp.	disp.
MA10-153	153	16	disp.	disp.	disp.	
MA10-160	160	16	disp.	disp.	disp.	



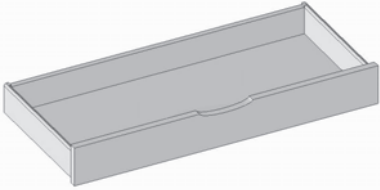
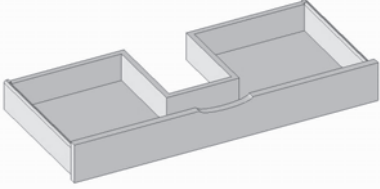
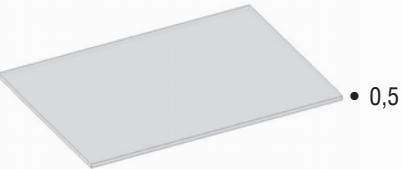
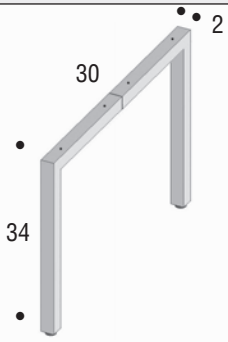
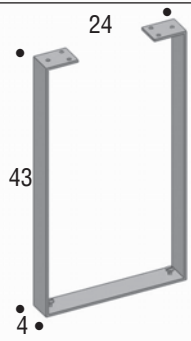
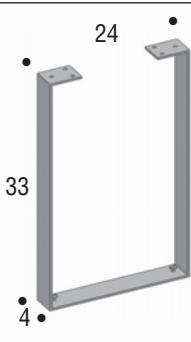
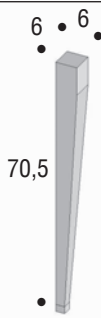
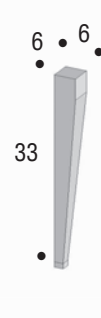
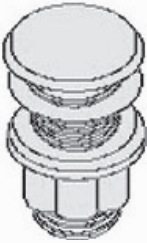

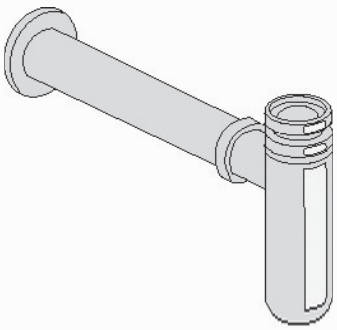
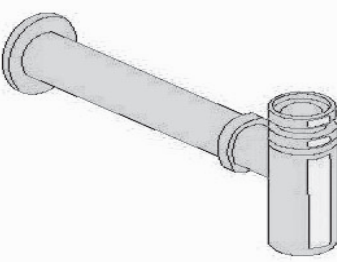
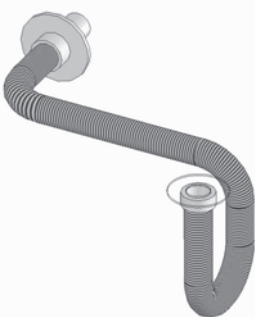

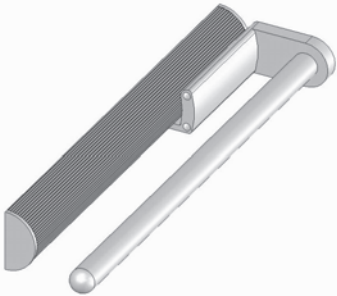
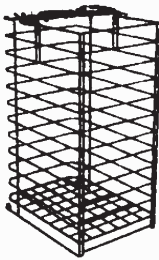
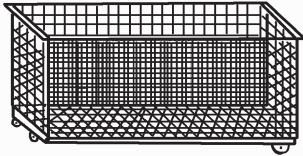
Elemento	Articolo	Larghezza	Altezza	Profondità	Laccato Opaco
  <p>Cassetto interno per basi e colonne, richiamo frenato e sponde metalliche. Frontale cassetto finitura alluminio.</p> <p>Quando il cassetto interno è montato nelle basi portalavabo, viene realizzata automaticamente la sagomatura per il sifone.</p>	TC2-24	24	11	30/42	disp.
	TC2-34	34	11	30/42	disp.
	TC2-48	48	11	30/42	disp.
	TC2-60	60	11	30/42	disp.
	TC2-68	68	11	30/42	disp.
	TC2-70	70	11	30/42	disp.
	TC2-90	90	11	30/42	disp.
	TC2-92	92	11	30/42	disp.
	TC2-102	102	11	30/42	disp.
	TC2-105	105	11	30/42	disp.
	TC2-116	116	11	30/42	disp.
 <p>ripiani in vetro (spessore 5 mm) per basi, pensili e colonne completi di supporti</p>	misure basi, pensili e colonne				
	RI-100	17 x 17/36/40			disp.
	RI-101	17 x 17/36/40			disp.
	RI-102	17 x 17/36/40			disp.
	RI-103	17 x 17/36/40			disp.
	RI-104	17 x 17/36/40			disp.
	RI-105	17 x 51/53/58			disp.
	RI-106	17 x 51/53/58			disp.
	RI-107	17 x 51/53/58			disp.
	RI-108	17 x 51/53/58			disp.
	RI-109	17 x 51/53/58			disp.
	RI-110	17 x 51/53/58			disp.
RI-111	17 x 51/53/58			disp.	



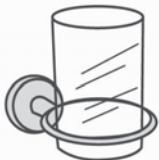

Elemento	Articolo	Larghezza	Altezza	Finitura	€
 <p>ruota carenata+freno per basi sospese</p>	<p>MC-P6M 1 ruota +freno</p> <p>MC-P6MK kit 4 ruote (2 con freno)</p>	3,5	10	ottone cromato e ABS finitura alluminio	disp.
 <p>piedino cromato regolabile in altezza</p>	<p>MC-P4 1 piedino</p> <p>MC-P4K kit 4 piedini</p>	Ø 4,5	10	ABS cromato	disp.
 <p>piedino regolabile in altezza</p>	<p>BC-P1 1 piedino</p> <p>BC-P1K kit 4 piedini</p>	2,5	10	acciaio cromato	disp.
 <p>piedino regolabile in altezza</p>	<p>BC-P3 1 piedino</p> <p>BC-P3K kit 4 piedini</p>	4	10	ottone cromato	disp.



Elemento	Articolo	Larghezza	Altezza	Finitura	€
 <p>30 34 2</p> <p>pieдино doppio regolabile</p>	<p>MC-P7 1 piedino</p> <p>MC-P3K kit 2 piedini</p>	2,5	33	<p>in ottone cromato</p> <p>per basi H.50</p>	<p>disp.</p> <p>disp.</p>
 <p>24 43 4</p> <p>gamba con viti di regolazione</p>	<p>MG050 1 gamba</p> <p>MG050K kit 2 gambe</p>	4	43	<p>ottone verniciato bianco</p> <p>per basi H.40</p>	<p>disp.</p> <p>disp.</p>
 <p>24 33 4</p> <p>gamba con viti di regolazione</p>	<p>MG060 1 gamba</p> <p>MG060K kit 2 gambe</p>	4	33	<p>ottone verniciato bianco</p> <p>per basi H.50</p>	<p>disp.</p> <p>disp.</p>
 <p>6 6 70,5</p> <p>gamba sagomata con terminale</p>	<p>GA0010 1 gamba</p>	6	70,5	<p>legno con terminale cromo</p> <p>per consolle in legno</p>	<p>laccato opaco disp.</p> <p>laccato lucido disp.</p> <p>essenze legno disp.</p>
 <p>6 6 33</p> <p>gamba sagomata con terminale</p>	<p>GA0020 1 gamba</p>	6	33	<p>legno con terminale cromo</p> <p>per basi H.50</p>	<p>laccato opaco disp.</p> <p>laccato lucido disp.</p> <p>essenze legno disp.</p>

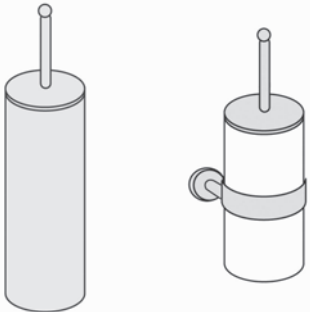

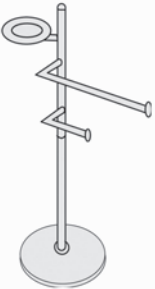
Elemento	Articolo	Larghezza	Altezza	Finitura	€
 <p>piletta fissa scarico libero</p>	P500	Ø72	55/144 Altezza regolabile	ABS cromato	disp.
 <p>piletta "apri e chiudi"</p>	P600	Ø72	55/144 Altezza regolabile	ABS cromato	disp.
 <p>sifone a vista cromo da 1"1/4</p>	S700	Ø50	143/391 Altezza regolabile	ABS cromato	disp.
 <p>sifone salvaspazio a vista cromo 1"1/4</p>	S800	Ø50	120/160 Altezza regolabile	ABS cromato	disp.
 <p>tubo di scarico flessibile di raccordo</p>	passepartout ®	Ø32	800	metallo cromato corrugato	disp.

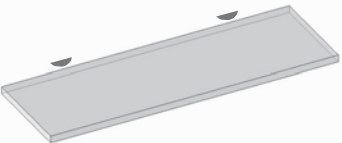
Elemento	Articolo	Larghezza	Altezza	Finitura	€
 portasciugamani estraibile	MC-PS 1 braccio MC-PSA 2 bracci	4	8	ABS cromato	disp. disp.
 cestello p.biancheria estraibile su guide	MC-CS2	per basi cm 34	37	acciaio cromato	disp.
 cestello p.biancheria estraibile su guide	MC-CS5	per basi cm 48-68	37	acciaio cromato	disp.
 carrello 3 cassetti con top e ruote	BCM-21	34	62	laccato opaco / nobilitato laccato lucido essenze legno	disp. disp. disp.
 carrello 2 cassetti con top e ruote	BCM-24	48	60	laccato opaco / nobilitato laccato lucido essenze legno	disp. disp. disp.

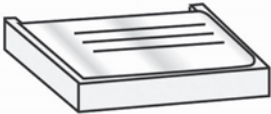
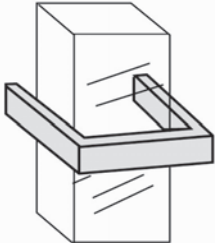
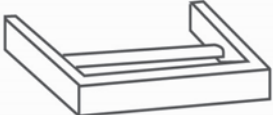

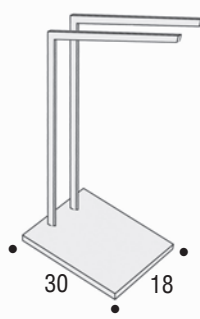

Elemento	Articolo	Larghezza	Altezza	Finitura	Cromo Lucido	Cromo Satinato
 porta sapone	H20-1	12	4,5	Ottone cromo lucido o satinato Piattino in vetro acidato	disp.	disp.
 porta bicchiere	H20-2	7	9	Ottone cromo lucido o satinato Bicchiera in vetro acidato	disp.	disp.
 porta carta	H20-3	14	4,5	Ottone cromo lucido o satinato	disp.	disp.
 porta abito	H20-4	4,5	4,5	Ottone cromo lucido o satinato	disp.	disp.
 H20-5A	H20-5A	30	4,5	Ottone cromo lucido o satinato	disp.	disp.
 H20-5	H20-5	40	4,5	Ottone cromo lucido o satinato	disp.	disp.
 porta salviette cm 30/40/60	H20-6	60	4,5	Ottone cromo lucido o satinato	disp.	disp.

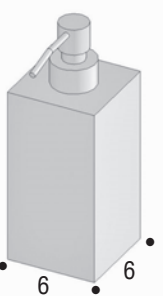
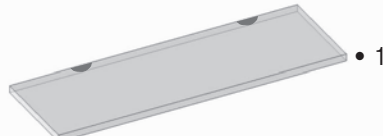

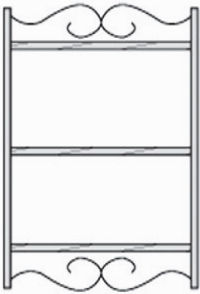
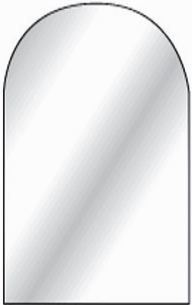

Elemento	Articolo	Larghezza	Altezza	Finitura	Cromo Lucido	Cromo Satinato
 <p>porta scopino a terra o a parete</p>	<p>H20-7 <i>p.scopino a terra</i></p> <p>H20-8 <i>p.scopino a parete</i></p>	<p>Ø8</p> <p>Ø8</p>	<p>33</p> <p>33</p>	<p>Ottone cromo lucido o satinato</p> <p>Ottone cromo lucido o satinato e vetro acidato</p>	<p>disp.</p> <p>disp.</p>	<p>disp.</p> <p>disp.</p>
 <p>piantana 2 bracci porta salviette</p>	<p>H20-9</p>	<p>30</p>	<p>84</p>	<p>Ottone cromo lucido</p>	<p>disp.</p>	
 <p>piantana con p. carta e p. sapone</p>	<p>H20-10</p>	<p>30</p>	<p>71</p>	<p>Ottone cromo lucido e piattino in vetro acidato</p>	<p>disp.</p>	
 <p>dosatore da appoggio o a parete</p>	<p>H20-11 <i>dosatore appoggio</i></p> <p>H20-12 <i>dosatore a parete</i></p>	<p>Ø7</p> <p>Ø7</p>	<p>16</p> <p>16</p>	<p>Ottone cromo lucido</p>	<p>disp.</p> <p>disp.</p>	
 <p>mensola cristallo attacchi parete cromo</p>	<p>BC-8</p>	<p>al cm addebito minimo</p>	<p>1</p> <p>1</p>	<p>Cristallo trasparente o satinato Prezzo al cm lineare</p> <p>Cristallo colorato (colori di serie) Prezzo al cm lineare</p>		

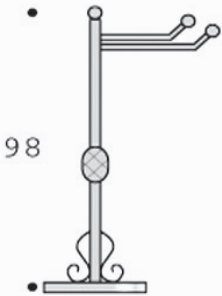

Elemento	Articolo	Larghezza	Altezza	Finitura	Cromo Lucido	Cromo Satinato
 porta sapone	MINI1	15	4	Ottone cromo lucido o satinato Piatino in vetro acidato	disp.	disp.
 porta bicchiere	MINI2	9	10	Ottone cromo lucido o satinato Bicchiere in vetro acidato	disp.	disp.
 porta rotolo	MINI3	15	2	Ottone cromo lucido o satinato	disp.	disp.
 porta abito	MINI4	2	3	Ottone cromo lucido o satinato	disp.	disp.
 porta salviette cm 30/40/60	MINI5A MINI5 MINI6	30 40 60	2 2 2	Portasalviette cm 30 Portasalviette cm 40 Portasalviette cm 60	disp. disp. disp.	disp. disp. disp.

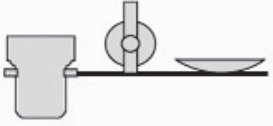

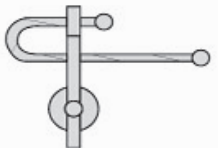
Elemento	Articolo	Larghezza	Altezza	Finitura	Cromo Lucido	Cromo Satinato
 <p>porta scopino a terra</p>	MINI7	8	36	Ottone cromo lucido o satinato	disp.	disp.
 <p>piantana a due bracci</p>	MINI8	18	84	Ottone cromo lucido o satinato	disp.	disp.
 <p>piantana porta carta</p>	MINI9	18	48	Ottone cromo lucido o satinato	disp.	disp.
 <p>dosasapone da appoggio o parete</p>	MINI10 <i>dosatore appoggio</i>	6	16	ottone cromato	disp.	
	MINI10A <i>dosatore a parete</i>	6	16		disp.	
 <p>mensola cristallo attacchi parete cromo</p>	BC-8	al cm addebito minimo	1 1	Cristallo trasparente o satinato Prezzo al cm lineare Cristallo colorato (colori di serie) Prezzo al cm lineare		

Elemento	Articolo	Larghezza	Altezza	Profondità	Finitura colori anticati (come da catalogo)	
 <p>base sospesa in ferro battuto anticato</p>	IT-1	82	50	37	<p>Base sospesa senza top</p> <p>Base sospesa con top ceramica</p>	<p>disp.</p> <p>disp.</p>
 <p>base sospesa in ferro battuto anticato</p>	IT-2	102	50	37	<p>Base sospesa senza top</p> <p>Base sospesa con top ceramica</p>	<p>disp.</p> <p>disp.</p>
 <p>base a terra in ferro battuto anticato</p>	IT-3	82	82	37	<p>Base sospesa senza top</p> <p>Base sospesa con top ceramica</p>	<p>disp.</p> <p>disp.</p>
 <p>base a terra in ferro battuto anticato</p>	IT-4	102	82	37	<p>Base sospesa senza top</p> <p>Base sospesa con top ceramica</p>	<p>disp.</p> <p>disp.</p>

Elemento	Articolo	Larghezza	Altezza	Profondità	Finitura colori anticati (come da catalogo)	
 <p>pensile in ferro battuto</p>	IT-15	30	60	13	Colori anticati	disp.
 <p>specchiera cornice in ferro battuto</p>	IT-S1	70	100	2	Colori anticati	disp.
 <p>illuminazione a parete</p>	ROBY OLD	30	25	22	Colori anticati	disp.
 <p>piantana 2 bracci base marmo carrara</p>	IT-14	45	98	34 (48 con base)	Colori anticati	disp.
 <p>porta sapone (dx o sx)</p>	IT/04	12	16	20	Colori anticati	disp.

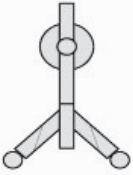
Elemento	Articolo	Larghezza	Altezza	Profondità	Finitura colori anticati (come da catalogo)	
 <p>Porta sapone + bicchiere o doppio</p>	IT/04A	32	15	14	Porta sapone + bicchiere	disp.
	IT/04D	34	15	14	Porta sapone doppio	disp.
 <p>porta bicchiere (dx o sx)</p>	IT/05	9	17	17	Colori anticati	disp.
 <p>porta rotolo</p>	IT/06	17	12	11	Colori anticati	disp.
 <p>asta cm 40</p>	IT/07	40	14	10	Colori anticati	disp.
 <p>asta cm 60</p>	IT/08	60	14	10	Colori anticati	disp.

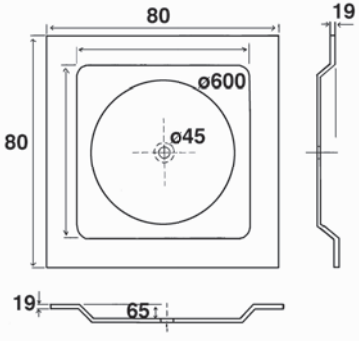
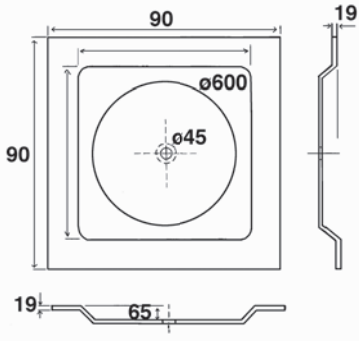
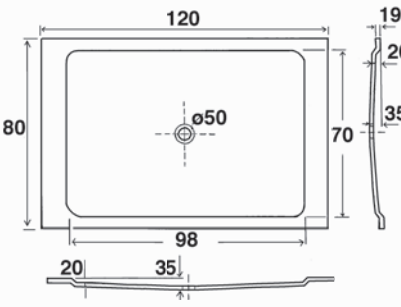
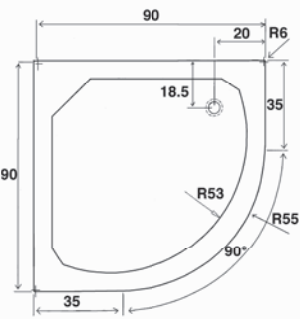
Elemento	Articolo	Larghezza	Altezza	Profondità	Finitura colori anticati (come da catalogo)	
 asta cm 30	IT/09	30	14	10	Colori anticati	disp.
 anello cm 30	IT/10	30	26	7	Colori anticati	disp.
 porta scopino sospeso in ceramica	IT/11	10	30	19	Colori anticati	disp.
 attaccapanni	IT/12	9	16	7	Colori anticati	disp.

Elemento	Articolo	Larghezza	Altezza		* Cristallo colorato
 <p>piatto doccia in cristallo</p>	<p>PO/01</p> <p>PO/01A</p>	<p>80x80</p> <p>80x80</p>	<p>7,5</p> <p>8,5</p>	<p>da incasso a pavimento</p> <p>da appoggio con profili</p>	<p>disp.</p> <p>disp.</p>
 <p>piatto doccia in cristallo</p>	<p>PO/02</p> <p>PO/02A</p>	<p>90x90</p> <p>90x90</p>	<p>7,5</p> <p>8,5</p>	<p>da incasso a pavimento</p> <p>da appoggio con profili</p>	<p>disp.</p> <p>disp.</p>
 <p>piatto doccia in cristallo</p>	<p>PO/03</p> <p>PO/03A</p>	<p>120x80</p> <p>120x80</p>	<p>7,5</p> <p>8,5</p>	<p>da incasso a pavimento</p> <p>da appoggio con profili</p>	<p>disp.</p> <p>disp.</p>
 <p>piatto doccia in cristallo</p>	<p>PO/04</p>	<p>90x90</p>	<p>7,5</p>	<p>da incasso a pavimento</p>	<p>disp.</p>
 <p>scarico cromo per piatto doccia</p>	<p>P400</p>			<p>cromo</p>	<p>disp.</p>

* I piatti doccia in cristallo non sono disponibili nei colori: Rosso Arancio (ARX99), Argento (AR81), Rame (RA93), Bianco (BI84), Mandarino (MA85), Rosa Chiaro (RO82), Oro (GOLD93), Pervinca (PE92), Ciclamino (CL96), Madreperla (MP95)

Elemento	Articolo	Larghezza	Altezza		Staron		
 <p>piatto doccia su misura in Staron da cm 80L a cm 190L</p> <p>Profondità da cm. 70 a cm. 85, altezza cm.6</p>	PO/05	80/90	6		disp.		
	PO/06	90/100	6		disp.		
	PO/07	100/110	6		disp.		
	PO/08	110/120	6		disp.		
	PO/09	120/130	6		disp.		
	PO/10	130/140	6		disp.		
	PO/11	140/150	6		disp.		
	PO/12	150/160	6		disp.		
	PO/13	160/170	6		disp.		
	PO/14	170/180	6		disp.		
	PO/15	190/190	6		disp.		
 <p>piatto doccia su misura in Staron da cm 80L a cm 190L</p> <p>Profondità da cm. 85 a cm. 95, altezza cm.6</p>	PO/16	80/90	6		disp.		
	PO/17	90/100	6		disp.		
	PO/18	100/110	6		disp.		
	PO/19	110/120	6		disp.		
	PO/20	120/130	6		disp.		
	PO/21	130/140	6		disp.		
	PO/22	140/150	6		disp.		
	PO/23	150/160	6		disp.		
	PO/24	160/170	6		disp.		
	PO/25	170/180	6		disp.		
	PO/26	190/190	6		disp.		
 <p>piastra in staron per sostegno vetro</p>	PO/05P	70/96			disp.		

Elemento	Articolo	Larghezza	Altezza	Profondità	Tecnoril opaco	Tecnoril lucido
 <p>vasca da bagno in tecnoril</p>	MT10	170	50	70	disp.	disp.

Schede tecniche vasca Art. MT10

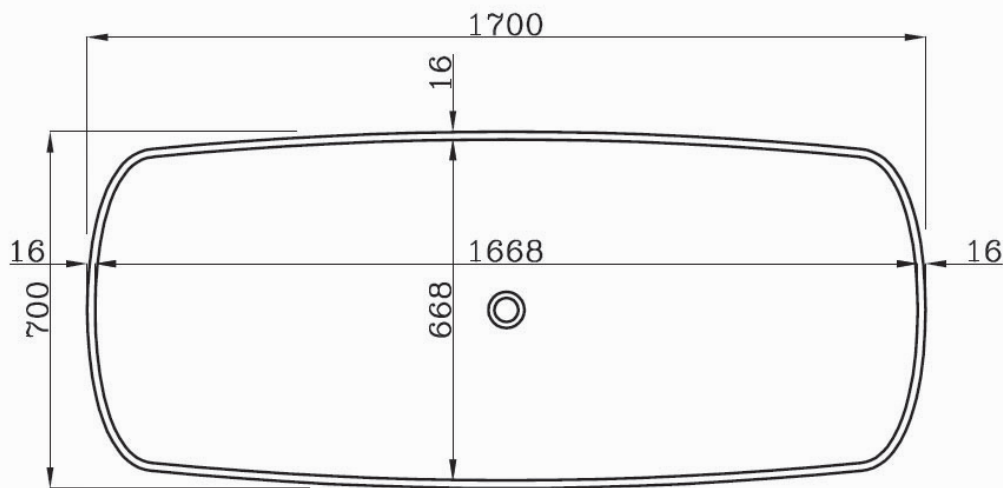

Kg: 95 circa
 Capienza acqua: Litri 300 circa
 Scarico troppo pieno: compreso

Maggiorazione prezzo per kit completo di piletta click-clack da 1,5", coperchio in tinta vasca, sifone e raccordi.
 Art. MT20K

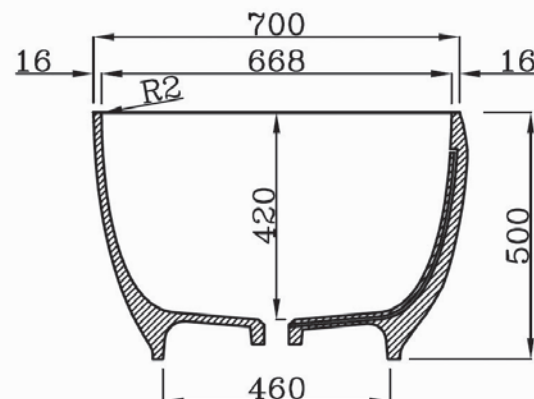
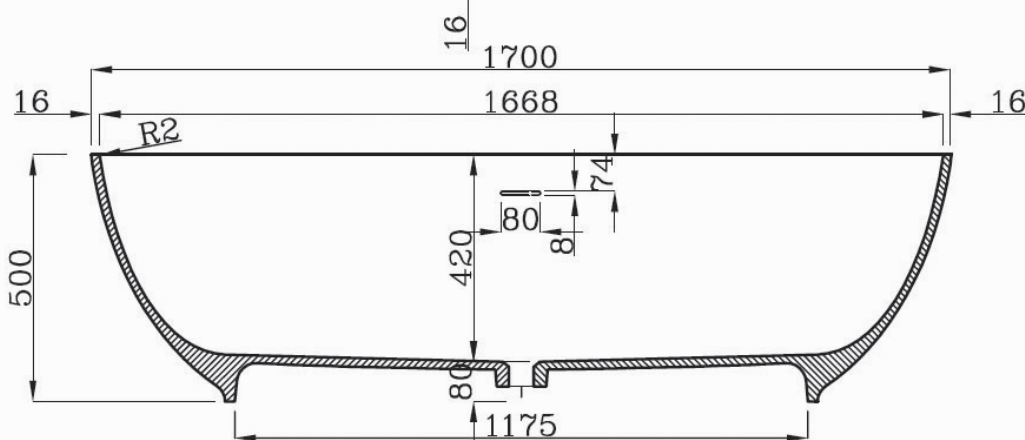

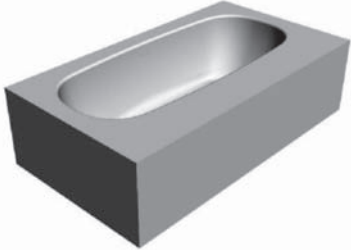
Elemento	Articolo	Larghezza	Altezza	Profondità	Tecnoril opaco	Tecnoril lucido
	MT11	Min. 175	52	Min. 75	disp.	disp.
		Max. 200		Max. 105		
	MT11A				disp.	disp.
vasca da bagno su misura in tecnoril						
Pannello singolo, lato lungo (compresa saldatura)	MT11B				disp.	disp.
Pannello singolo, lato corto (compresa saldatura)						

Schede tecniche vasca Art. MT11

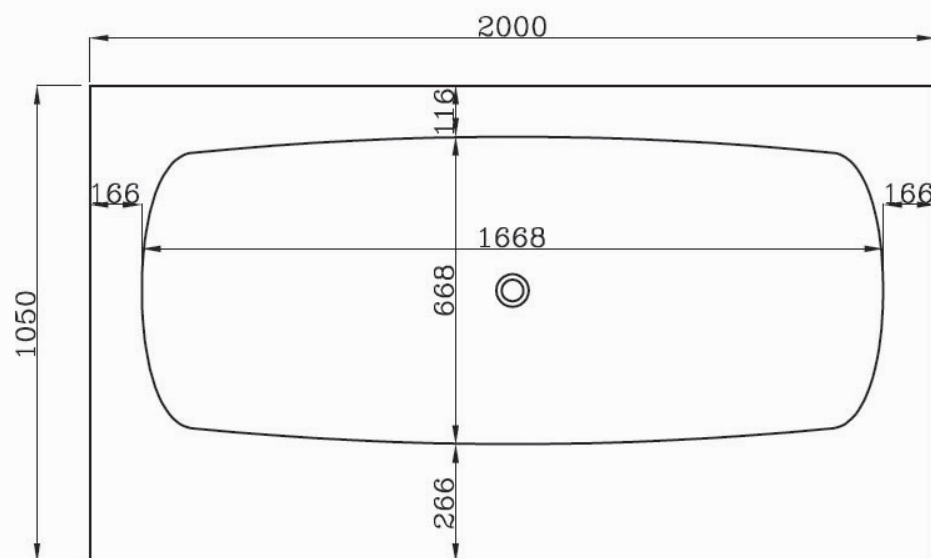

Kg: 125 circa (escluso pannelli dei fianchi)

Capienza acqua: Litri 300 circa
Scarico troppo pieno: compreso

Maggiorazione prezzo per kit completo di piletta click-clack da 1,5", coperchio in tinta vasca, sifone e raccordi.

Art. MT20K

