



METROPOLIS

Collezione componibile disponibile nelle versioni
LACCATO OPACO/LUCIDO e LEGNO.

IMPORTANTE:

Tutte le basi con frontali curvi non sono disponibili nelle finiture
LEGNO EBANO, TEAK, ZEBRANO CHIARO,
ZEBRANO SCURO, ZEBRANO CENERE.

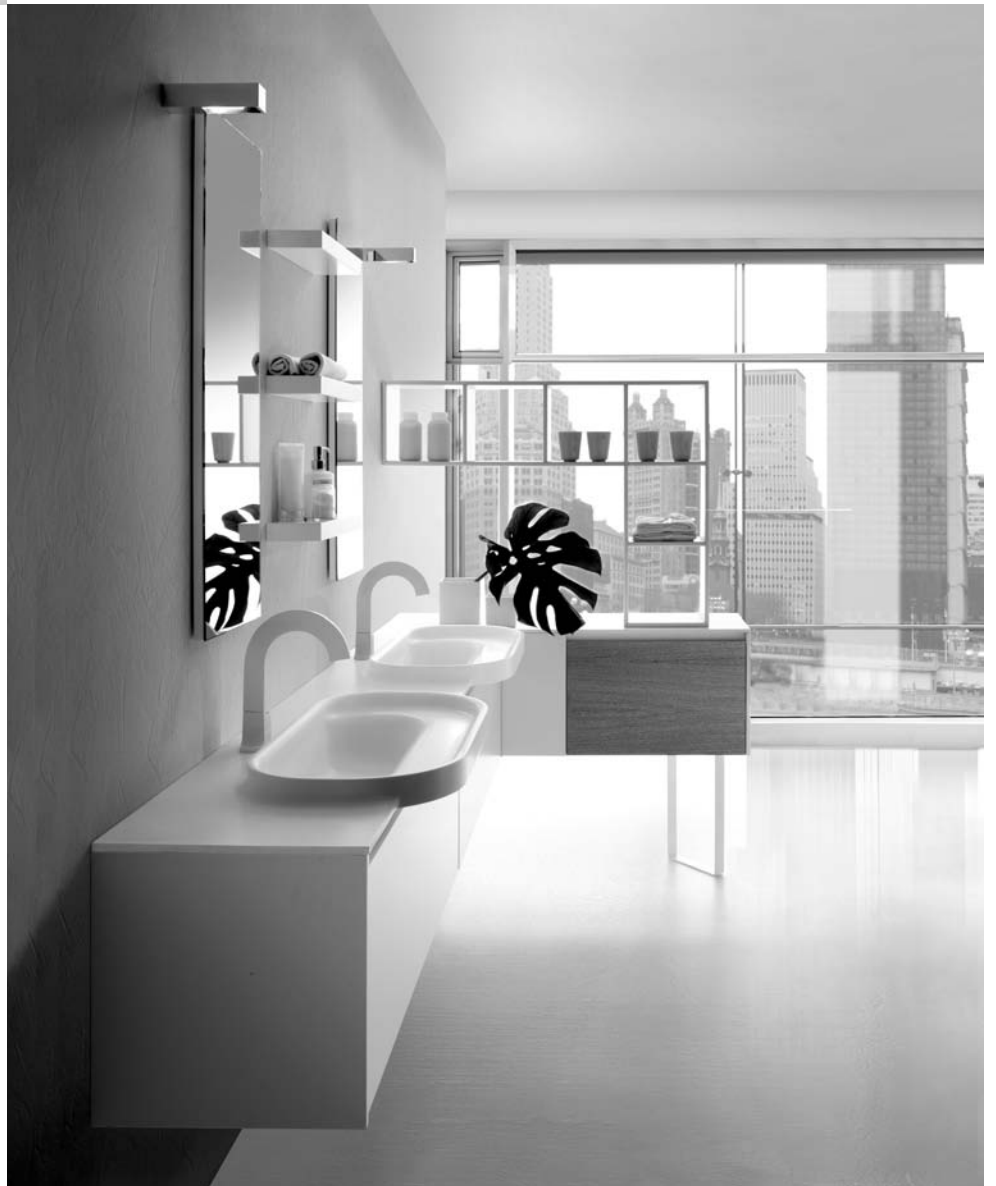

STRUTTURE SOSPese **H.8** per pianilavabo - incluso attacchi

METROPOLIS
L I N E A

METROPOLIS

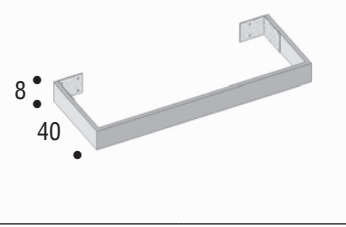
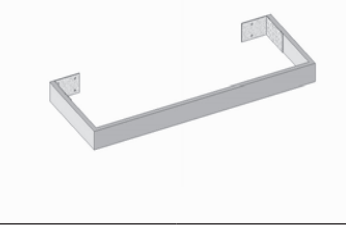
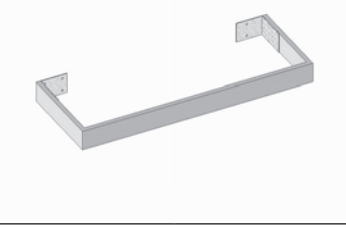
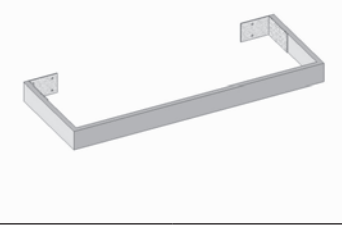
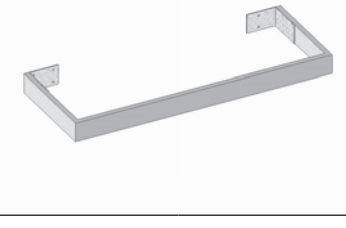
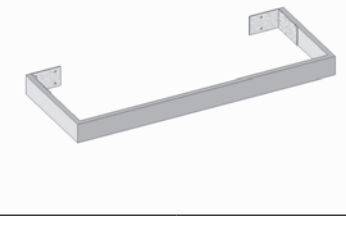
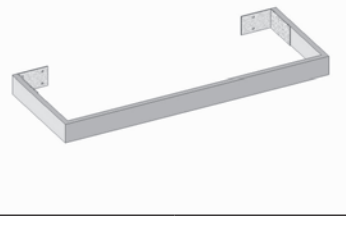
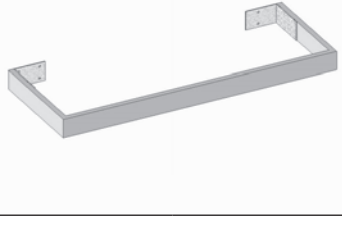
	larghezza 70	larghezza 90	larghezza 105	larghezza 120
STRUTTURE PORTANTI IN LEGNO PER PIANILAVABO IN TECNORIL				
	struttura per pianilavabo in Tecnoril	struttura per pianilavabo in Tecnoril	struttura per pianilavabo in Tecnoril	struttura per pianilavabo in Tecnoril
PROFONDITÀ	P 40	P 40	P 40	P 40
ARTICOLO	MT001	MT002	MT003	MT004
laccato opaco	disp.	disp.	disp.	disp.
laccato lucido	disp.	disp.	disp.	disp.
essenze legno	disp.	disp.	disp.	disp.
	larghezza 130	larghezza 140	larghezza 160	larghezza 180
				
	struttura per pianilavabo in Tecnoril	struttura per pianilavabo in Tecnoril	struttura per pianilavabo in Tecnoril	struttura per pianilavabo in Tecnoril
PROFONDITÀ	P 40	P 40	P 40	P 40
ARTICOLO	MT005	MT006	MT007	MT008
laccato opaco	disp.	disp.	disp.	disp.
laccato lucido	disp.	disp.	disp.	disp.
essenze legno	disp.	disp.	disp.	disp.

Strutture portanti in legno inclusi fissaggi a parete per pianilavabo Metropolis in Tecnoril pag. 45-46

BASI PORTALAVABO SOSPESE **H.40** senza top

METROPOLIS
L I N E A

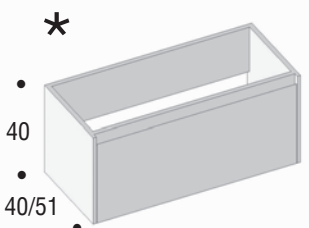
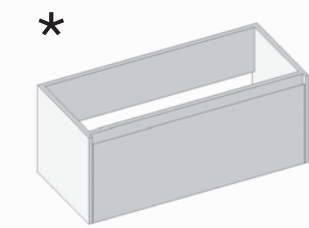
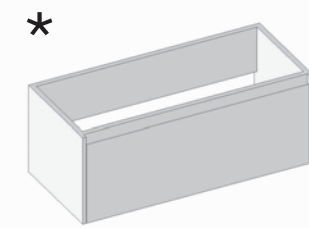
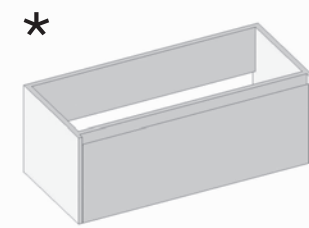
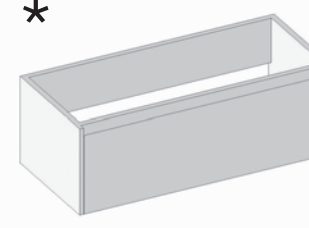
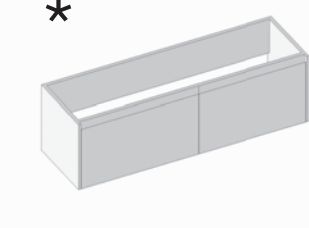
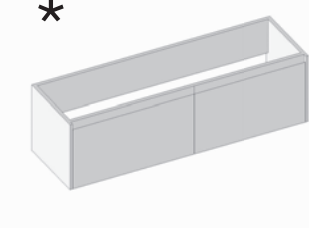
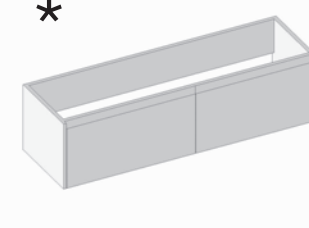
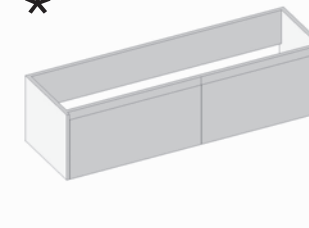
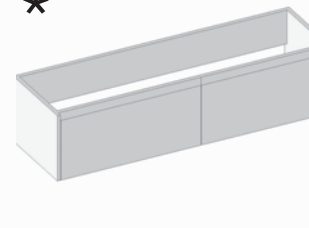
	larghezza 45		larghezza 70		larghezza 90		larghezza 105	
PORTALAVABO ESCLUSO TOP								
	1 cassettone		1 cassettone		1 cassettone		1 cassettone	
PROFONDITÀ	P 40	P 51	P 40	P 51	P 40	P 51	P 40	P 51
ARTICOLO	MT101	MT102	MT103	MT104	MT105	MT106	MT107	MT108
laccato opaco	disp.	disp.	disp.	disp.	disp.	disp.	disp.	disp.
laccato lucido	disp.	disp.	disp.	disp.	disp.	disp.	disp.	disp.
essenze legno	disp.	disp.	disp.	disp.	disp.	disp.	disp.	disp.
	larghezza 120		larghezza 130		larghezza 140		larghezza 160	
								
	1 cassettone		2 cassettoni		2 cassettoni		2 cassettoni	
PROFONDITÀ	P 40	P 51	P 40	P 51	P 40	P 51	P 40	P 51
ARTICOLO	MT109	MT110	MT111	MT112	MT113	MT114	MT115	MT116
laccato opaco	disp.	disp.	disp.	disp.	disp.	disp.	disp.	disp.
laccato lucido	disp.	disp.	disp.	disp.	disp.	disp.	disp.	disp.
essenze legno	disp.	disp.	disp.	disp.	disp.	disp.	disp.	disp.
	larghezza 180		larghezza 210					
					<p>* AGGIUNTA PREZZO PER CASSETTO INTERNO (Art.TC2) €</p> <p>CON CASSA LEGNO E ANTA LACCATA OPACO/LUCIDO = PREZZO LEGNO</p> <p>CON CASSA LACCATA OPACO/LUCIDO E ANTA LEGNO=PREZZO LACCATO LUCIDO</p>			
	2 cassettoni		2 cassettoni					
PROFONDITÀ	P 40	P 51	P 40	P 51				
ARTICOLO	MT117	MT118	MT119	MT120				
laccato opaco	disp.	disp.	disp.	disp.				
laccato lucido	disp.	disp.	disp.	disp.				
essenze legno	disp.	disp.	disp.	disp.				

BASI PORTALAVABO **H.71** sospese, **H.81** zoccolo/piedini

METROPOLIS
L I N E A

METROPOLIS

	larghezza 45		larghezza 70		larghezza 90		larghezza 105	
PORTALAVABO ESCLUSO TOP								
	2 cassettoni H.35,5		2 cassettoni H.35,5		2 cassettoni H.35,5		2 cassettoni H.35,5	
PROFONDITÀ	P 40	P 51	P 40	P 51	P 40	P 51	P 40	P 51
ARTICOLO	MT201	MT202	MT203	MT204	MT205	MT206	MT207	MT208
laccato opaco	disp.	disp.	disp.	disp.	disp.	disp.	disp.	disp.
laccato lucido	disp.	disp.	disp.	disp.	disp.	disp.	disp.	disp.
essenze legno	disp.	disp.	disp.	disp.	disp.	disp.	disp.	disp.

	larghezza 120		larghezza 130		larghezza 140		larghezza 160	
	2 cassettoni H.35,5		4 cassettoni H.35,5		4 cassettoni H.35,5		4 cassettoni H.35,5	
PROFONDITÀ	P 40	P 51	P 40	P 51	P 40	P 51	P 40	P 51
ARTICOLO	MT209	MT210	MT211	MT212	MT213	MT214	MT215	MT216
laccato opaco	disp.	disp.	disp.	disp.	disp.	disp.	disp.	disp.
laccato lucido	disp.	disp.	disp.	disp.	disp.	disp.	disp.	disp.
essenze legno	disp.	disp.	disp.	disp.	disp.	disp.	disp.	disp.

	larghezza 70		larghezza 90		larghezza 105		larghezza 135	
	2 ante		2 ante		3 ante		3 ante	
PROFONDITÀ	P 40	P 51	P 40	P 51	P 40	P 51	P 40	P 51
ARTICOLO	MT217	MT218	MT219	MT220	MT221	MT222	MT223	MT224
laccato opaco	disp.	disp.	disp.	disp.	disp.	disp.	disp.	disp.
laccato lucido	disp.	disp.	disp.	disp.	disp.	disp.	disp.	disp.
essenze legno	disp.	disp.	disp.	disp.	disp.	disp.	disp.	disp.

NB: CON CASSA LEGNO E ANTA LACCATA OPACO/LUCIDO = PREZZO LEGNO
CON CASSA LACCATA OPACO/LUCIDO E ANTA LEGNO = PREZZO LACCATO LUCIDO

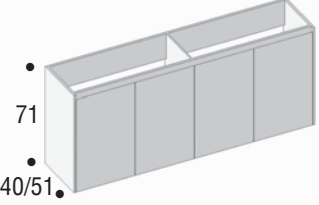
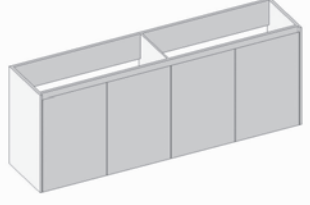
	larghezza 140		larghezza 180			
PORTALAVABO ESCLUSO TOP					<p>QUANDO VENGONO MONTATI LAVABI DA APPOGGIO L'ALTEZZA DELLE BASI CON ZOCCOLO SARA' DI CM 76.</p>	
	4 ante		4 ante			
PROFONDITÀ	P 40	P 51	P 40	P 51		
ARTICOLO	MT225	MT226	MT227	MT228		
laccato opaco	disp.	disp.	disp.	disp.		
laccato lucido	disp.	disp.	disp.	disp.		
essenze legno	disp.	disp.	disp.	disp.		

CON CASSA LEGNO E ANTA LACCATA
OPACO/LUCIDO = **PREZZO LEGNO**

CON CASSA LACCATA OPACO/LUCIDO E
ANTA LEGNO = **PREZZO LACCATO LUCIDO**

INDICARE SEMPRE IN ORDINE SE VERSIONE SOSPESA, CON ZOCCOLO O CON PIEDINO.
CON ZOCCOLO A TERRA STESSO PREZZO DELLE BASI SOSPESE. MAGGIORAZIONE
PREZZO PER KIT 4 PIEDINI METALLICI ART. BC-P1K €

BASI **H.40** sospese, **H.45** con zoccolo - incluso top

METROPOLIS
L I N E A

METROPOLIS

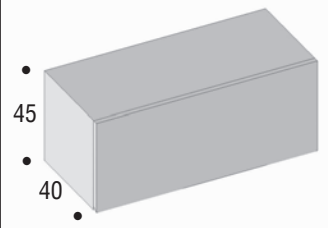
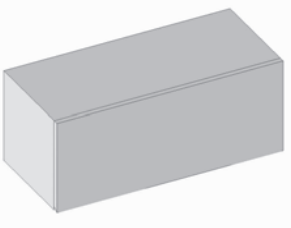
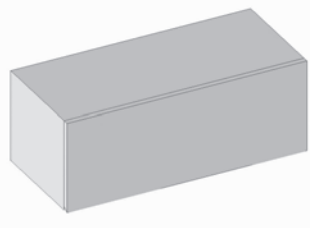
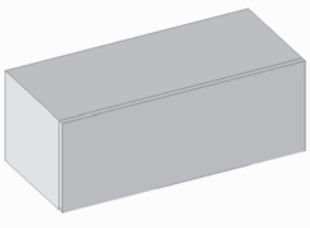
	larghezza 45		larghezza 70		larghezza 90		larghezza 105	
BASI SOSPESSE O CON ZOCCOLO INCLUSO TOP								
	1 cassettone		1 cassettone		1 cassettone		1 cassettone	
PROFONDITÀ	P 40	P51	P 40	P51	P 40	P51	P 40	P51
ARTICOLO	MT301	MT301B	MT302	MT302B	MT303	MT303B	MT304	MT304B
laccato opaco	disp.	disp.	disp.	disp.	disp.	disp.	disp.	disp.
laccato lucido	disp.	disp.	disp.	disp.	disp.	disp.	disp.	disp.
essenze legno	disp.	disp.	disp.	disp.	disp.	disp.	disp.	disp.

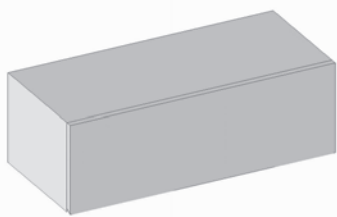
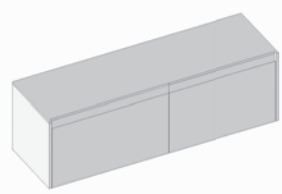
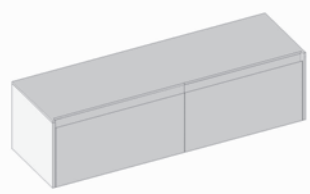
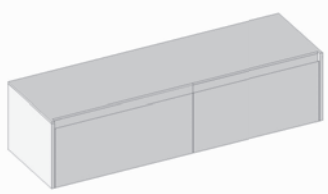
	larghezza 120		larghezza 130		larghezza 140		larghezza 160	
								
	1 cassettone		2 cassettoni		2 cassettoni		2 cassettoni	
PROFONDITÀ	P 40	P51	P 40	P51	P 40	P51	P 40	P51
ARTICOLO	MT305	MT305B	MT306	MT306B	MT307	MT307B	MT308	MT308B
laccato opaco	disp.	disp.	disp.	disp.	disp.	disp.	disp.	disp.
laccato lucido	disp.	disp.	disp.	disp.	disp.	disp.	disp.	disp.
essenze legno	disp.	disp.	disp.	disp.	disp.	disp.	disp.	disp.

**CON CASSA LEGNO E ANTA LACCATA
OPACO/LUCIDO = PREZZO LEGNO**

**CON CASSA LACCATA OPACO/LUCIDO E
ANTA LEGNO = PREZZO LACCATO LUCIDO**

**INDICARE SEMPRE IN ORDINE SE VERSIONE SOSPESA O CON ZOCCOLO.
CON ZOCCOLO A TERRA STESSO PREZZO DELLE BASI SOSPESSE.**

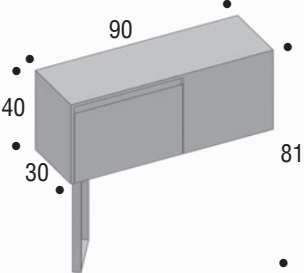
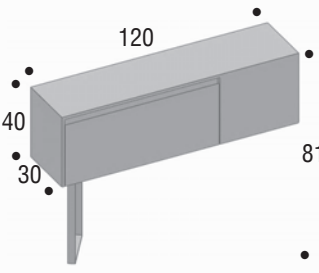
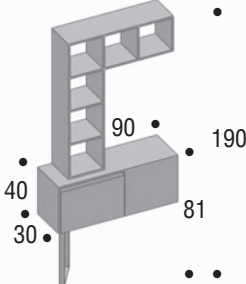
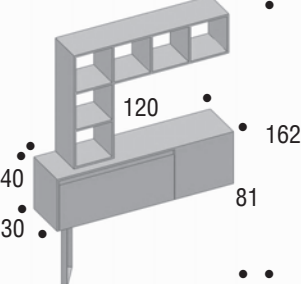
	larghezza 30		larghezza 30		larghezza 30		larghezza 30	
PENISOLE								
	1 ribalta		1 ribalta		1 ribalta + elemento a giorno		1 ribalta + elemento a giorno	
PROFONDITÀ	P 90		P 120		P 90		P 120	
ARTICOLO	MT350		MT351		MT352		MT353	
laccato opaco	disp.		disp.		disp.		disp.	
laccato lucido	disp.		disp.		disp.		disp.	
essenze legno	disp.		disp.		disp.		disp.	

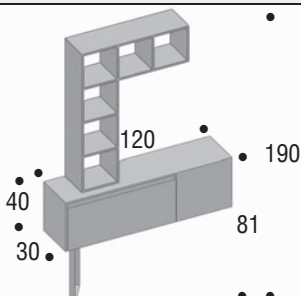
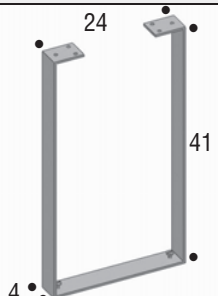
	larghezza 30				larghezza 4	
PENISOLE						
	1 ribalta + elemento a giorno				gamba in metallo verniciato bianco	
PROFONDITÀ	P 120				PROFONDITÀ	P 24
ARTICOLO	MT355				ARTICOLO	MG050
laccato opaco	disp.				metallo bianco	disp.
laccato lucido	disp.					
essenze legno	disp.					

**CON CASSA LEGNO E ANTA LACCATA
OPACO/LUCIDO = PREZZO LEGNO**

**CON CASSA LACCATA OPACO/LUCIDO E
ANTA LEGNO = PREZZO LACCATO LUCIDO**

	70		70,1-90		90,1-105		105,1-120	
LAVABO CENTRALE DX O SX								
	pianolavabo tecnoril opaco/lucido		pianolavabo tecnoril opaco/lucido		pianolavabo tecnoril opaco/lucido		pianolavabo tecnoril opaco/lucido	
	tecnoril opaco	tecnoril lucido	tecnoril opaco	tecnoril lucido	tecnoril opaco	tecnoril lucido	tecnoril opaco	tecnoril lucido
ARTICOLO	MT401	MT401L	MT402	MT402L	MT403	MT403L	MT404	MT404L
tecnoril	disp.	disp.	disp.	disp.	disp.	disp.	disp.	disp.
	120,1-130		130,1-140		140,1-150		150,1-160	
LAVABO CENTRALE DX O SX								
	pianolavabo tecnoril opaco/lucido		pianolavabo tecnoril opaco/lucido		pianolavabo tecnoril opaco/lucido		pianolavabo tecnoril opaco/lucido	
	tecnoril opaco	tecnoril lucido	tecnoril opaco	tecnoril lucido	tecnoril opaco	tecnoril lucido	tecnoril opaco	tecnoril lucido
ARTICOLO	MT405	MT405L	MT406	MT406L	MT407	MT407L	MT408	MT408L
tecnoril	disp.	disp.	disp.	disp.	disp.	disp.	disp.	disp.
	160,1-170		170,1-190		190,1-210		210,1-250	
SOLO LAVABO CENTRALE								
	pianolavabo tecnoril opaco/lucido		pianolavabo tecnoril opaco/lucido		pianolavabo tecnoril opaco/lucido		pianolavabo tecnoril opaco/lucido	
	tecnoril opaco	tecnoril lucido	tecnoril opaco	tecnoril lucido	tecnoril opaco	tecnoril lucido	tecnoril opaco	tecnoril lucido
ARTICOLO	MT409	MT409L	MT410	MT410L	MT411	MT411L	MT412	MT412L
tecnoril	disp.	disp.	disp.	disp.	disp.	disp.	disp.	disp.

NB: ANCHE CON LATERALI SAGOMATI SENZA AUMENTO DI PREZZO

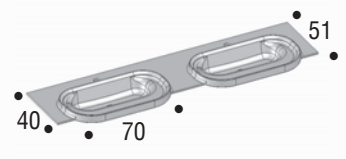
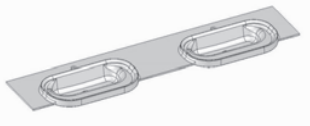
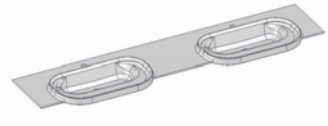
	larghezza 160,1-190		larghezza 190,1-210		larghezza 210,1-250		
DOPPIO LAVABO							
	pianolavabo tecnoril opaco/lucido		pianolavabo tecnoril opaco/lucido		pianolavabo tecnoril opaco/lucido		
	tecnoril opaco	tecnoril lucido	tecnoril opaco	tecnoril lucido	tecnoril opaco	tecnoril lucido	
ARTICOLO	MT451	MT451L	MT452	MT452L	MT453	MT453L	
tecnoril	disp.	disp.	disp.	disp.	disp.	disp.	

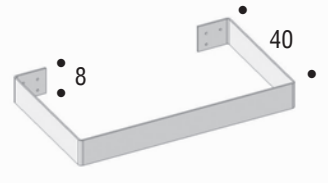
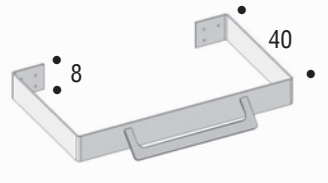
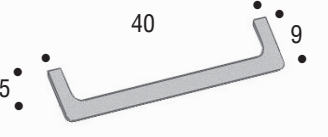
	larghezza 70		larghezza 70		larghezza 40		
STRUTTURA PORTANTE PER PIANILAVABO IN TECNORIL							
	struttura supporto per pianilavabo		struttura supporto con portasalviette		portasalviette in metallo bianco		
	P 40		P 40		P 9		
ARTICOLO	MT490		MT491		MG070		
metallo bianco	disp.		disp.		disp.		

**SULLE BASI PORTALAVABO
METROPOLIS LINEA POSSONO ESSERE MONTATE
ANCHE LE CONSOLLE TWING IN MINERALMARMO
ART. MRG-70/90/105/120, MRZ-70/90/105/120/120A
ED IN CERAMICA ART. MRM-60/90 E MRP-70/105/120**

**PER ALTRE TIPOLOGIE TOP
VEDERE PAG. 193 - 211**

BASI PORTALAVABO SOSPESE **H.47** - senza top

METROPOLIS
C U R V O

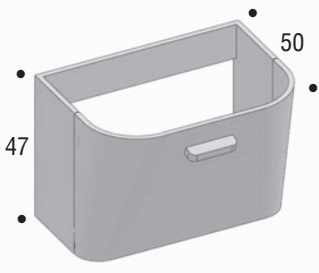
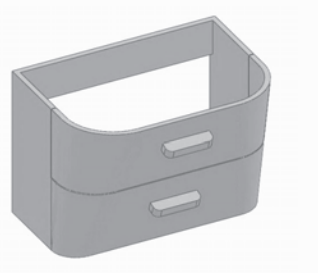



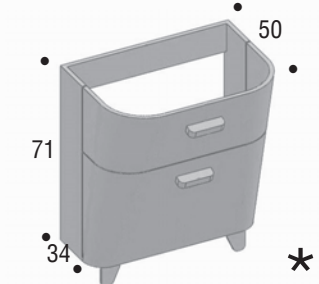



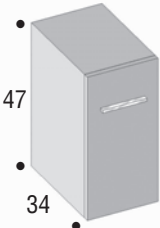

	larghezza 70	larghezza 70		
PORTALAVABO INCASSO O APPOGGIO ESCLUSO TOP				
	1 cassettone	2 cassettoni H.25		
PROFONDITÀ	P 50	P 50		
ARTICOLO	MT501	MT502		
laccato opaco	disp.	disp.		
laccato lucido	disp.	disp.		
essenze legno	disp.	disp.		



BASI PORTALAVABO **H.71** SOSPESE, **H.81** CON PIEDINI - senza top

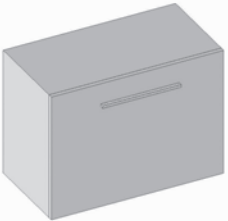

	larghezza 70			
PORTALAVABO INCASSO O APPOGGIO ESCLUSO TOP		* Aggiunta prezzo per kit 2 piedini (Art. BC-P3 x2) €32		
	1 cassetto H.25 e 1 cassetto H.46			
PROFONDITÀ	P 50			
ARTICOLO	MT503			
laccato opaco	disp.			
laccato lucido	disp.			
essenze legno	disp.			

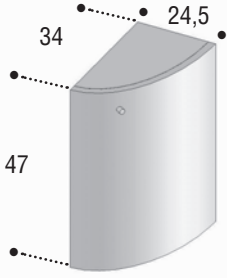
BASI SOSPESE H. 47 - senza top

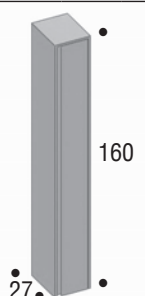
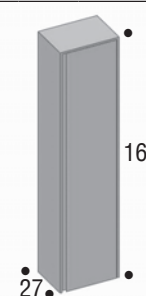
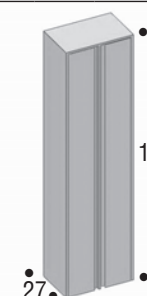
METROPOLIS
CURVO

	larghezza 24		larghezza 24		larghezza 24		larghezza 34	
BASI								
	1 anta dx/sx + ripiano interno		1 cassettone		2 cassettoni H.25		1 anta dx/sx + ripiano interno	
PROFONDITÀ	P 34		P 34		P 34		P 34	
ARTICOLO	MT601		MT602		MT603		MT604	
laccato opaco	disp.		disp.		disp.		disp.	
laccato lucido	disp.		disp.		disp.		disp.	
essenze legno	disp.		disp.		disp.		disp.	
	larghezza 34		larghezza 34		larghezza 48		larghezza 48	
								
	1 cassettone		2 cassettoni		1 cassettone		2 cassettoni	
PROFONDITÀ	P 34		P 34		P 34		P 34	
ARTICOLO	MT605		MT606		MT607		MT608	
laccato opaco	disp.		disp.		disp.		disp.	
laccato lucido	disp.		disp.		disp.		disp.	
essenze legno	disp.		disp.		disp.		disp.	
	larghezza 68		larghezza 68				larghezza 24,5	
					BASE TERMINALE			
	1 cassettone		2 cassettoni				terminale 1 anta curva dx-sx + ripiano	
PROFONDITÀ	P 34		P 34				P 34	
ARTICOLO	MT609		MT610				MT611	
laccato opaco	disp.		disp.				disp.	
laccato lucido	disp.		disp.				disp.	
essenze legno	disp.		disp.				disp.	

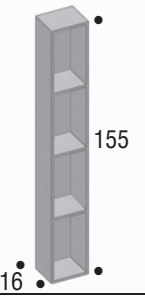
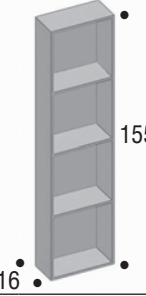
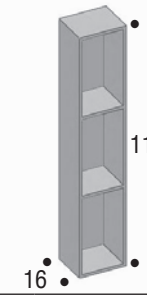
	larghezza 25		larghezza 38		larghezza 50		larghezza 76	
COLONNE SOSPESSE CON APERTURA A GOLA								
	1 anta dx-sx e ripiani interni		1 anta dx-sx e ripiani interni		2 ante e ripiani interni		2 ante e ripiani interni	
PROFONDITÀ	P 27		P 27		P 27		P 27	
ARTICOLO	MT705		MT707		MT709		MT711	
laccato opaco	disp.	Aggiunta prezzo kit 4 piedini Art. BC-P1K €	disp.	Aggiunta prezzo kit 4 piedini Art. BC-P1K €	disp.	Aggiunta prezzo kit 4 piedini Art. BC-P1K €	disp.	Aggiunta prezzo kit 4 piedini Art. BC-P1K €
laccato lucido	disp.		disp.		disp.		disp.	
essenze legno	disp.		disp.		disp.		disp.	

	larghezza 22		larghezza 38		larghezza 22		larghezza 38	
ELEMENTI A GIORNO SOSPESI								
	elemento a giorno con schienale		elemento a giorno con schienale		elemento a giorno con schienale		elemento a giorno con schienale	
PROFONDITÀ	P 16		P 16		P 16		P 16	
ARTICOLO	MT701		MT703		MT720		MT721	
laccato opaco	disp.	Versione con 1 anta dx-sx, stessa finitura scocca, +12%	disp.	Versione con 1 anta dx-sx, stessa finitura scocca, +12%	disp.	Versione con 1 anta dx-sx, stessa finitura scocca, +12%	disp.	Versione con 1 anta dx-sx, stessa finitura scocca, +12%
laccato lucido	disp.		disp.		disp.		disp.	
essenze legno	disp.		disp.		disp.		disp.	

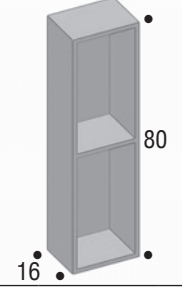
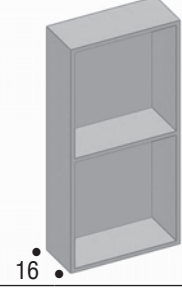
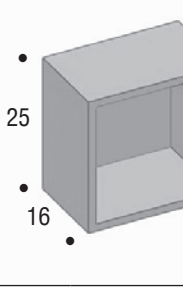
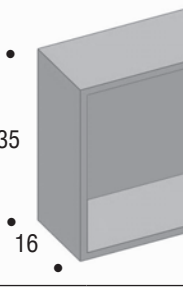
	larghezza 22		larghezza 38		larghezza 25		larghezza 35	
								
	elemento a giorno con schienale		elemento a giorno con schienale		elemento a giorno con schienale		elemento a giorno con schienale	
PROFONDITÀ	P 16		P 16		P 16		P 16	
ARTICOLO	MT814		MT816		MT820		MT821	
laccato opaco	disp.	Versione con 1 anta dx-sx, stessa finitura scocca, +12%	disp.	Versione con 1 anta dx-sx, stessa finitura scocca, +12%	disp.		disp.	
laccato lucido	disp.		disp.		disp.		disp.	
essenze legno	disp.		disp.		disp.		disp.	

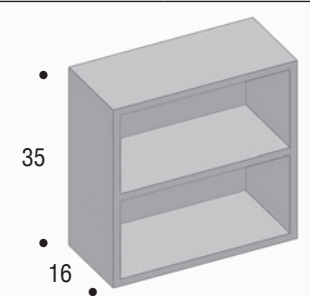
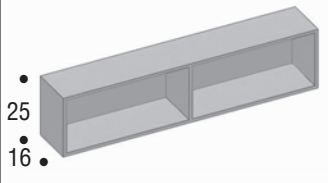

NB: CON CASSA LEGNO E ANTA LACCATA OPACO/LUCIDO = PREZZO LEGNO
 CON CASSA LACCATA OPACO/LUCIDO E ANTA LEGNO = PREZZO LACCATO LUCIDO

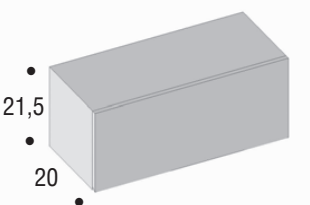
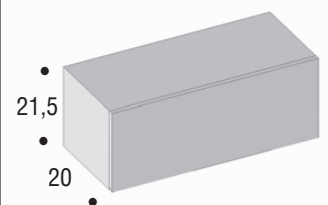
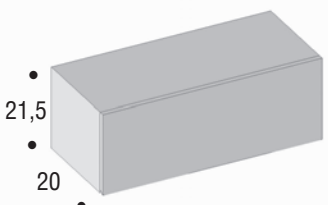
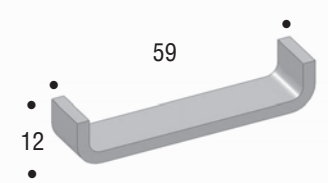
	larghezza 35	larghezza 105		
ELEMENTI A GIORNO SOSPESI				
	elemento a giorno con schienale	elemento a giorno con schienale		
PROFONDITÀ	P 16	P 16		
ARTICOLO	MT822	MT817		
laccato opaco	disp.	disp.		
laccato lucido	disp.	disp.		
essenze legno	disp.	disp.		

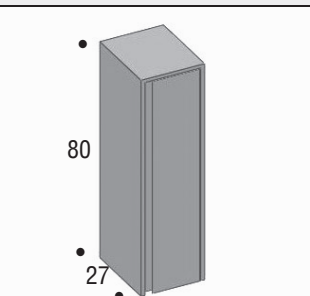
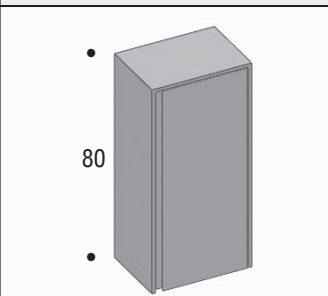
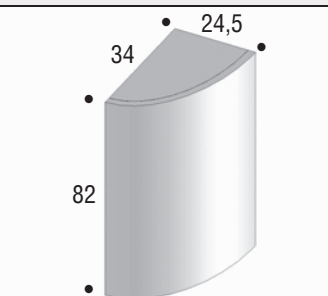
	larghezza 42	larghezza 72	larghezza 105	larghezza 59
PENSILI E MENSOLA				
	pensile con ribalta	pensile con ribalta	pensile con ribalta	mensola curva con attacchi
PROFONDITÀ	P 20	P 20	P 20	P 12
ARTICOLO	MT800	MT801	MT802	MT807
laccato opaco	disp.	disp.	disp.	disp.
laccato lucido	disp.	disp.	disp.	disp.
essenze legno	disp.	disp.	disp.	disp.

	larghezza 25	larghezza 38	larghezza 24,5	
				
	pensile 1 anta	pensile 1 anta	pensile curvo 1 anta dx-sx con top	
PROFONDITÀ	P 27	P 27	P 34	
ARTICOLO	MT810	MT812	MT805	
laccato opaco	disp.	disp.	disp.	
laccato lucido	disp.	disp.	disp.	
essenze legno	disp.	disp.	disp.	

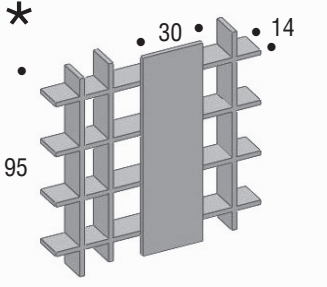
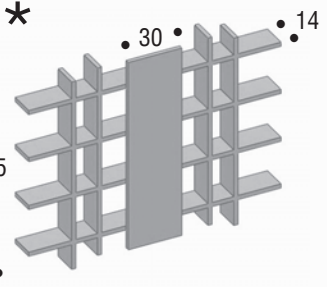
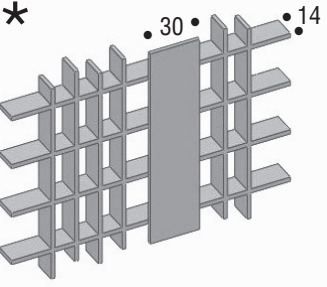
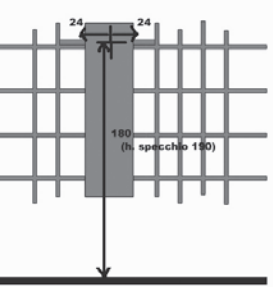
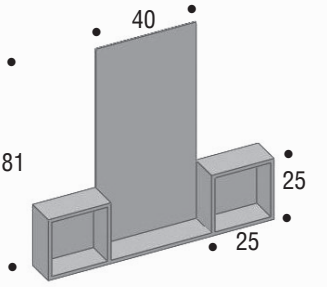
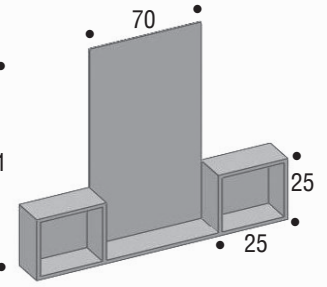
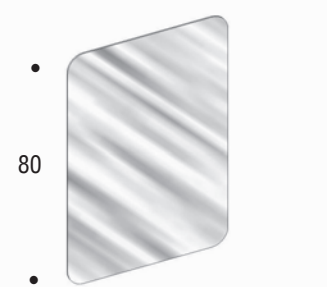
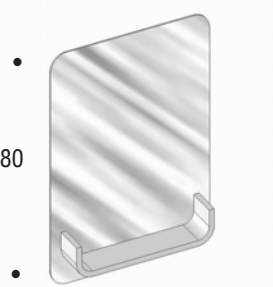
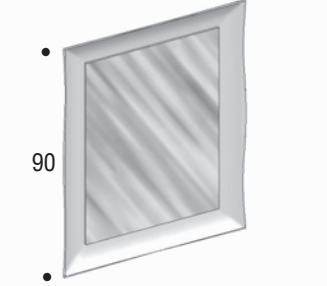
NB: CON CASSA LEGNO E ANTA LACCATA OPACO/LUCIDO = PREZZO LEGNO
 CON CASSA LACCATA OPACO/LUCIDO E ANTA LEGNO = PREZZO LACCATO LUCIDO

	larghezza 85		larghezza 118		larghezza 141		posizione punto luce a parete	
SPECCHIERE								
	specchiera scorrevole su mensola		specchiera scorrevole su mensola		specchiera scorrevole su mensola		* Aggiunta prezzo per lampada led in ottone cromato ed impianto elettrico per Art. MT901, MT903, MT905. Art. MT505 €	
PROFONDITÀ	P 14		P 14		P 14			
ARTICOLO	MT901		MT903		MT905			
laccato opaco	disp.		disp.		disp.			
laccato lucido	disp.		disp.		disp.			
essenze legno	disp.		disp.		disp.			
	larghezza 90		larghezza 120		larghezza 60		larghezza 60	
								
	specchiera con elementi a giorno		specchiera con elementi a giorno		specchiera		specchiera con mensola curva	
PROFONDITÀ	P 16		P 16		P 2		P 14	
ARTICOLO	MT911		MT913		MT920		MT921	
laccato opaco	disp.		disp.		disp.		disp.	
laccato lucido	disp.		disp.		disp.		disp.	
essenze legno	disp.		disp.		disp.		disp.	
	larghezza 70		larghezza 70					
								
	specchio FRAME senza illuminazione		Specchio FRAME con lampada led					
PROFONDITÀ	P 4		P 4		P 10		P 10	
ARTICOLO	FRAME01		FRAME01A		FRAME02		FRAME02A	
corn. specchio	disp.		disp.		disp.		disp.	
cornice vetro bianco	disp.		disp.		disp.		disp.	